

**NOTICE OF MEETING TO BE HELD BY THE
HISTORIC PRESERVATION COUNCIL
WEDNESDAY, APRIL 24, 2024 - 9:00 AM
MCALLEN DEVELOPMENT CENTER – 311 NORTH 15TH STREET**

AGENDA

At any time during the course of this meeting, the Historic Preservation Council may retire to Executive Session under Texas Government Code 551.071(2) to confer with its legal counsel on any subject matter on this agenda in which the duty of the attorney to the Historic Preservation Council under the Texas Disciplinary Rules of Professional Conduct of the State Bar of Texas clearly conflicts with Chapter 551 of the Texas Government Code. Further, at any time during the course of this meeting, the Historic Preservation Council may retire to Executive Session to deliberate on any subject slated for discussion at this meeting, as may be permitted under one or more of the exceptions to the Open Meetings Act set forth in Title 5, Subtitle A, Chapter 551, Subchapter D of the Texas Government Code.

CALL TO ORDER -

1. Minutes

- a) Approval or Disapproval of Minutes held on February 28, 2024

2. Public Hearing

- a) Request of Rene Gutierrez on behalf of McAllen ISD, Inc. for a Certificate of Appropriateness for the construction of an ornamental fence to the existing Historic Landmark located at 6.7 acres of Lot 9, Block Southwest ¼ 9, Hidalgo Canal CO-MC Subdivision, Hidalgo County, Texas; 1009 North 10th Street **(CLM2024-0001)**

4. Adjournment

C E R T I F I C A T I O N

I, the undersigned authority, do hereby certify that the above agenda for the meeting of the McAllen Historic Preservation Council is a true and correct copy and that I posted a true and correct copy of said notice on the bulletin board in the municipal building, a place convenient and readily accessible to the general public at all times, and said notice was posted on the 19th day of April, 2024 at 5:00 p.m. and will remain so posted continuously for at least 72 hours preceding the scheduled time of said meeting in accordance with Chapter 551 of the Texas Government Code.

Jessica Cavazos, Administrative Supervisor

**STATE OF TEXAS
COUNTY OF HIDALGO
CITY OF MCALLEN**

The Historic Preservation Council convened in a meeting on Wednesday, February 28, 2024 at 9:00 a.m. at the McAllen Development Center–311 North 15th Street, Planning Conference Rm. Room

Present:	Dr. Jaclyn Miller	Chairperson
	Danny Boultinghouse	Vice-Chairperson
	Carolina Civarolo	Member
	Melissa S. Knerr	Member
Absent:	David Cazares	Member
	Odette Macdonald	Member
	Trisha Scott	Member
Staff Present:	Evaristo Garcia	Assistant City Attorney III
	Omar Sotelo	Senior Planner
	Carmen White	Administrative Assistant

CALL TO ORDER – Dr. Jaclyn Miller - Chairperson

1. Minutes

- a) Approval or Disapproval of Minutes held on September 25, 2023

Mr. Danny Boultinghouse **moved** to approve the minutes. Ms. Carolina Civarolo **seconded** the motion. Motion approved with four board members present and voting.

2. Discussion and Possible Action

- a) FY 2024 CLG Grant Update

Mr. Edgar Garcia stated that at the meeting of September 25, 2023, the Board had agreed to apply for the grant at the end of November. Staff was notified in the month of April that the grant was not approved. There had been more requests than there was available funding. The funded cities were the City of Bryan, Corpus Christi, Allen and another City as well. Staff will move forward for City funding to do trolley tours. In hoping next year we can get some supplemental funding however going self-funding would be better. By doing so, for the future grants we could apply for the new survey. That was the update and no action was needed.

- b) Roosevelt Elementary School Update

Mr. Garcia stated that about four years ago, there was an attempt for the Roosevelt Elementary School located at Galveston Avenue and 16th Street. It was a Historical building and there was some contentious proposals, which was denied. M.I.S.D. is attempting to sell it. We now have a new interested purchaser, which was going well. They would like to make it into offices without touching the existing buildings. Currently the sale should be closing very soon and to expect sometime in March or April for a Certificate of Appropriateness.

3. Adjournment

Mr. Danny Boultinghouse made a **motion** to adjourn the meeting. Ms. Melissa Knerr **seconded** the motion, which passed unanimously with four members present and voting. The meeting was adjourned at 9:05 a.m.

Dr. Jaclyn Miller- Chairperson

ATTEST _____
Carmen White

MEMO

TO: Historic Preservation Council

FROM: Historic Preservation Officer

DATE: April 10, 2024

SUBJECT: REQUEST OF RENE GUTIERREZ ON BEHALF OF MCALLEN ISD, INC. FOR A CERTIFICATE OF APPROPRIATENESS FOR THE CONSTRUCTION OF AN ORNAMENTAL FENCE TO THE EXISTING HISTORIC LANDMARK LOCATED AT 6.7 ACRES OF LOT 9, BLOCK SOUTHWEST ¼ 9, HIDALGO CANAL CO-MC SUBDIVISION, HIDALGO COUNTY, TEXAS; 1009 NORTH 10TH STREET. (CLM2024-0001)

BACKGROUND: The property is located on the southwest corner of N. 10th Street and Jasmine Avenue. The lot size is approximately 291,852 square feet. The property is currently zoned R-1 (single family residential) District. The style of architecture of the building is Spanish Revival.

PROPOSAL: The applicant is proposing to install a black Montage plus fence fronting N. 10th Street and partially along Jasmine Avenue.

ANALYSIS: The property, also known as the Lamar Junior High School was designated as a City Landmark in 2007. The building on site was built in 1939 and designed by M.L. Waller and T.D. Waller. The building was renovated in 1984 but the façade received only minor changes to the windows.

The design review process for the Certification of Appropriateness is critical for a designated Historic Landmark to ensure the unique and defining characteristics of the building are maintained according to McAllen’s design standards.

1. *Consistency of Style* – New construction should not try to replicate the architectural styles of the past but should look to them for guidance on fenestration patterns, façade organization, level and extent of detailing, massing, roof forms and height, and materials used. New construction should reflect modern design but be sensitive to the historical architectural styles of the past.

The applicant submitted plans showing details of the black Montage plus fence and the proposed layout. The plans submitted comply with the consistency of style design standards.

2. *Materials* – New construction should maintain the characteristics of existing exterior materials.

Wrought Iron

3. *Setbacks* – To ensure consistency, new construction should follow existing ordinance requirements.

The applicant proposes a black Montage plus fence to be installed along property lines along N. 10th Street and Jasmine Avenue. The plans submitted comply with the design standards of a Historic Landmark for Block Southwest ¼ 9, Hidalgo Canal CO-MC Subdivision and will be verified during the building permit review.

CONCLUSION: The proposed fence is the only request being made by the applicant. There are no other changes being made to the exterior or interior of the Historic Landmark.

RECOMMENDATION: The plans submitted comply with the Historic Landmark Design Standards for the proposed building. Therefore, staff recommends approval of the Certificate of Appropriateness for the proposed black Montage plus fence as requested by the applicant.

HPC:
4/24/2024

CLM2024-0001

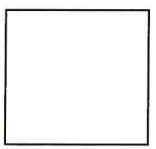

Date Received

HISTORIC PRESERVATION COUNCIL CERTIFICATE OF APPROPRIATENESS APPLICATION FORM

Required Items: Site plan, legal description, building elevations, final building plans and specifications, samples of paint colors, roofing materials, color photographs of structures and sites where construction will take place. NO CASE WILL BE SCHEDULED FOR A HEARING UNTIL ALL REQUIRED MATERIALS ARE RECEIVED. (See check lists on pages 3-6)

Property Location (Street Address) 1009 N 10th St. McAllen, Tx. 78501

Historic District Name _____

Landmark Name Lamar Junior High School

Legal Description Hidalgo Canal Co-MC 5 6.7 AC of Lot 9
Blk SW 1/4 9

Name of Property Owner: McAllen ISD

Mailing Address: 2000 N 23rd St. Zip Code: 78501

Telephone: 956-688-6000 Fax No. _____

E-Mail Address: melissa.ortiz@mcallenisd.net

(If different from Owner)
Name of Owner's Agent: Melissa Ortiz

Address: 4309 Warrior Dr. Zip Code: 78501

Business/Home Telephone: 956-637-3200 Fax No. _____

E-Mail Address: melissa.ortiz@mcallenisd.net

Owner is requesting permission to: (describe clearly and in detail all architectural alterations to be made in addition to other requests. An additional sheet may be used.

1. Installation of new ornamental fence

2. _____

3. _____

4. _____

This completed form is to be submitted ¹ in person at the Planning Department Office

APPROVAL BY THE HISTORIC PRESERVATION COUNCIL CONSTITUTES APPROVAL TO APPLY FOR A BUILDING PERMIT. BUILDING PERMITS MUST BE OBTAINED FROM THE CITY OF MCALLEN, PERMIT AND INSPECTIONS DEPARTMENT.

Owner understands the following:

1. If the Council fails to approve any portion of a request or recommends that changes be made in the plans and specifications, the owner will have five (5) days in which to inform the Historic Preservation Officer as to whether the owner agrees to the recommended changes.
2. Within ten (10) days from receipt of the recommendation, the Historic Preservation Officer shall notify the owner as to whether his request has been approved, conditionally approved or denied.
3. If the owner does not concur with the Council's recommendation, appeal to the Board of Commissioners may be made within the time specified in (Ord. Sec 138-419).

IF THE PROPERTY OWNER DOES NOT APPEAR PERSONALLY BEFORE THE COUNCIL, AN AUTHORIZATION SIGNED BY THE OWNER MUST BE PRESENTED TO THE HISTORIC PRESERVATION OFFICER, AUTHORIZING A REPRESENTATIVE TO APPEAR INSTEAD OR THE CASE WILL NOT BE HEARD.

I hereby authorize Rael Morales of McAllen ISD
(Name of representative) (Company or agency)

To represent me in matters pertaining to this case.

Owner's Name: Rene Gutierrez

Owner's Signature: Rene Gutierrez 3/25/24

Date 3-25-24

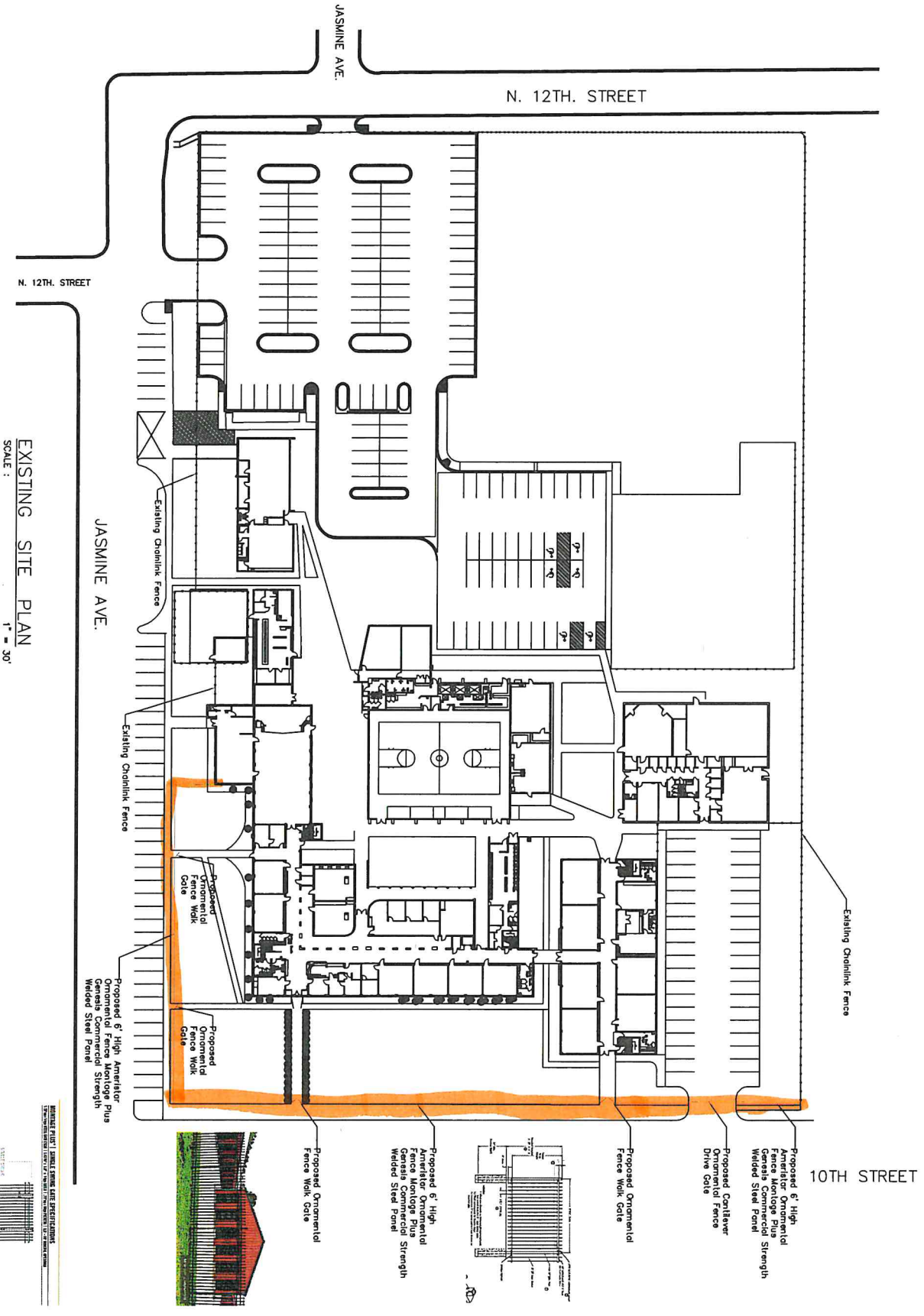

EXISTING SITE PLAN
SCALE: 1" = 30'

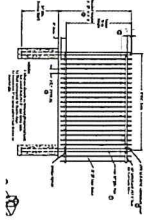
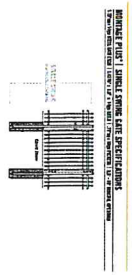

SHEET NO.
A-1

PROJECT NAME
LAMAR ACADEMY
1009 N. 29TH.
McALLEN, TEXAS
DRAWING NAME:
EXISTING SITE PLAN

McALLEN
INDEPENDENT SCHOOL DISTRICT
FACILITY PLANNING SERVICES

DESIGN BY:	DRAWN BY:	SCALE: as shown	DATE DRAWN:
REVISIONS			

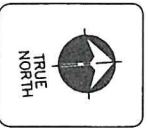

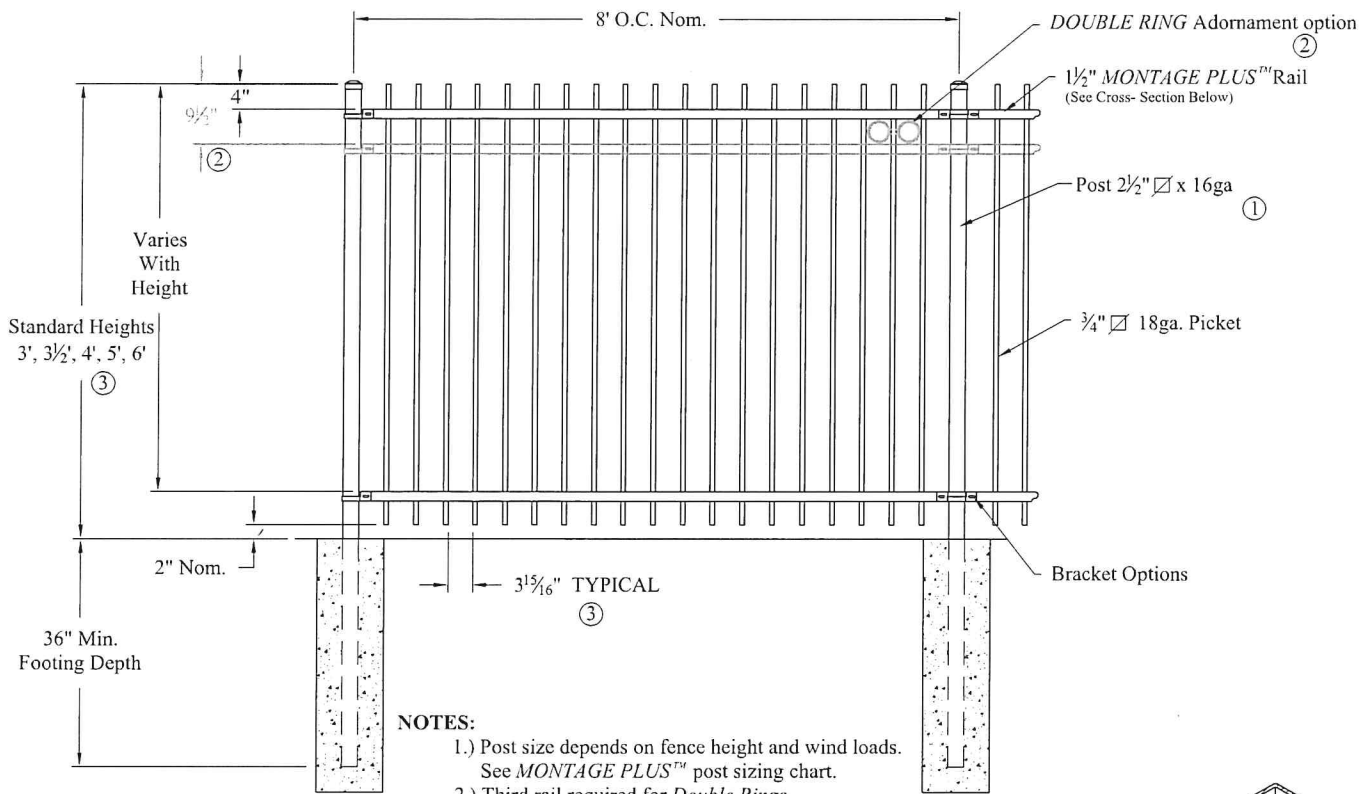

NOTES:

- 1.) Post size depends on fence height and wind loads. See MONTAGE PLUS™ post sizing chart.
- 2.) Third rail required for Double Rings.
- 3.) Available in 3" air space and/or Flush Bottom on most heights.

RAKING DIRECTIONAL ARROW
Welded panel can be raked 30" over 8' with arrow pointing down grade.

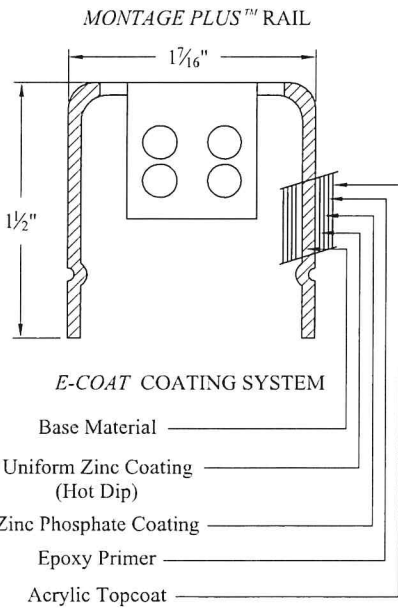

PROFUSION™ WELDING PROCESS
No exposed welds,
Good Neighbor profile - Same appearance on both sides

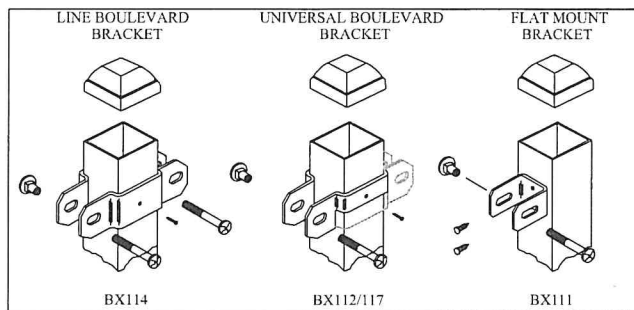
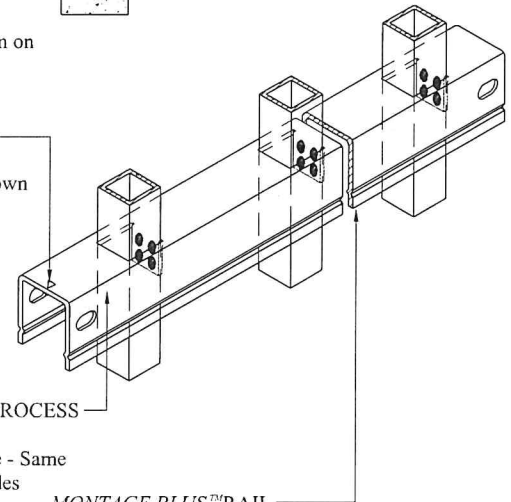

COMMERCIAL STRENGTH WELDED STEEL PANEL
PRE-ASSEMBLED

Values shown are nominal and not to be used for installation purposes. See product specification for installation requirements.

IRGISO

Title: MONTAGE PLUS GENESIS 2/3-RAIL			
DR: CI	SH. 1 of 1	SCALE: DO NOT SCALE	
CK: ME	Date 6/28/10	REV: e	



AMERISTAR®

1555 N. Mingo
Tulsa, OK 74116
1-888-333-3422
www.ameristarfence.com

The fence that we are proposing is a black Montage plus fence.





HISTORIC PRESERVATION COUNCIL

REQUIRED MATERIALS CHECK LIST

All background materials needed to support the applicant’s request must be submitted to the Historic Preservation Officer **PRIOR** to scheduling the case before the Council. **NO CASE** will be placed on the agenda if **ALL** materials are not on file by the deadline date. Any last minute changes must be shown on revised plans.

II. Check Where Applicable:

- Residence and/or Duplex
- Apartments and/or Commercial

III PROJECT TO INCLUDE (check where applicable):

- A ALTERATION/REPAIR/RESTORATION of an Existing Building or Structure
- B NEW CONSTRUCTION
- C ADDITION
- D DEMOLITION
- E SIGN REQUIREMENTS
- F FENCING
- G DRIVEWAY - SIDEWALKS & PARKING LOTS
- H REPAINTING (color change)
- I REROOFING (materials/color change)
- J SWIMMING POOLS - FISH PONDS & FOUNTAINS
- K GAZEBOS - BATH HOUSE & DECKING
- L WINDOWS

A ALTERATION/REPAIR/RESTORATION of an existing building or structure

- Scaled drawings, detailed architectural drawings may be required, dependent upon extent of work proposed.
- Photographs of the property and surrounding property, showing where work is to be done.
- A written list of proposed materials and colors, including manufacturer’s specification numbers.
- Actual samples of materials and colors should be presented at the meeting.
- Written narrative indicating the extent of the proposed alteration.
- Other information needed to illustrate the proposed alteration.

B. NEW CONSTRUCTION

- Preliminary plans with building elevations
- Working scale drawings/specifications
- Drawing 8½" X 11" reproducible sheets
- Scale site plan with square footage of the building
- Photographs of building site for new construction
- Paint samples with brand name and number
- Roofing material sample
- Siding sample

C. ADDITION

- Preliminary plans with building elevations
- Scale drawing of addition in relation to structure
- Working scale drawings/specifications
- Scale site plan
- Drawing 8½" X 11" reproducible sheets
- Photographs of structure showing current appearance
- Photographs of all exterior sides (include all four sides of building)
- Colors (sample)

D. DEMOLITION

- Photographs of structure (all exterior sides of structure)
- Scale site plan
- Proposed use after demolition (conceptual plan)
- Proof of economic hardship or unusual and compelling circumstances (required for demolition within a historic district or of a landmark)

E. SIGNAGE

- Working scale drawings/specifications
- Scale drawing of sign in relation to structure
- Scale site plan
- Drawing 8½" X 11" reproducible sheets
- Photograph of location of proposed signage on structure/property
- Photograph of structure and all exterior sides affected by proposed work
- Type of materials to be used for sign
- Colors (samples) as applied to sign
- Size/style of lettering
- Illumination Plan

F. **FENCING**

- Type/design of fence
- Scale of drawing of members with specifications
- Scale site plan
- Drawing 8½" X 11" reproducible sheets
- Photograph of structure and all exterior sides affected by proposed work

G. **DRIVEWAYS - SIDEWALKS & PARKING LOTS**

- Type/design of driveway/sidewalk
- Drawing 8½" X 11" reproducible sheets
- Scale site plan
- Photograph of structure, location and all exterior sides affected by proposed work
- Landscaping plans (if any)
- Colors (sample)

H. **REPAINTING (color change)**

- Type of material
- Colors (sample)
- Description of design
- Photographs of structure and all exterior sides affected by proposed work

I. **REROOFING (material/color change)**

- Type of material (sample or cut sheet)
- Colors (sample)
- Description of design
- Photographs of structure and all exterior sides affected by proposed work

J. **SWIMMING POOLS - FISH PONDS & FOUNTAINS**

- Working scale drawings/specifications
- Scale drawing in relation to structure
- Scale site plan
- Drawing 8½" X 11" reproducible sheets
- Type/design of swimming pool, fish pond and/or fountain
- Photographs of structure (all exterior sides) and area affected by proposed work
- Colors (sample)



K. GAZEBOS - BATH HOUSE & DECKING

- Working scale drawing/specifications
- Scale drawing in relation to structure
- Scale site plan
- Drawing 8½" X 11" reproducible sheets
- Photographs of structure (all exterior sides) and area affected by proposed work
- Colors (sample)

L. WINDOW REPLACEMENT

- Justification for replacement of windows
- Working scale drawings/specifications (material and color)
- Sample of proposed window (manufacturer brochure)
- Scale site plan designating number of windows to be replaced
- Drawing 8½" X 11" reproducible sheets
- Photographs of structure (all exterior sides) and area affected by proposed work

PLEASE BE ADVISED THAT THE COUNCIL HAS A POLICY OF ONLY HEARING A CASE WHEN THE OWNER OR THE OWNER'S REPRESENTATIVE IS PRESENT TO PRESENT THE CASE.

NOTE: PLEASE BE ADVISED THAT A STAFF MEMBER FROM THE PLANNING DEPARTMENT MAY VIDEOTAPE OR PHOTOGRAPH YOUR PROPERTY FOR THE HISTORIC PRESERVATION COUNCIL MEETING

MONTAGE PLUS®



ORNAMENTAL STEEL FENCE

Montage Plus ornamental steel fence has the *versatility to fit many different project applications*. With its ability to *traverse varying grades*, variety of *distinct product styles* and unmatched coating performance, Montage Plus is the *preferred choice for ornamental fence*.

PRIMARY APPLICATIONS

- *Commercial Developments*
- *Self Storage*
- *Apartments (Multi-Family)*
- *Parks & Recreation*
- *Schools & Universities*



AMERISTARFENCE.COM | 888-333-3422

ASSA ABLOY, the global leader in door opening solutions

AMERISTAR®

ASSA ABLOY

MONTAGE PLUS®

ORNAMENTAL STEEL FENCE

.75"sq x 18ga PICKETS | 1.4375" x 1.5" x 14ga RAILS | 2.5"sq x 16ga POSTS

Each picket is precisely welded at each rail intersection providing all-terrain flexibility and aesthetics.

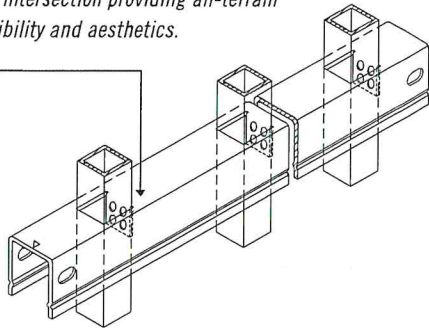

STYLE OPTIONS

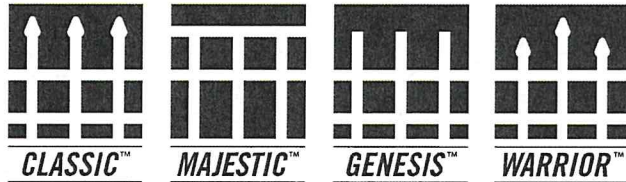

Also available in Pool, Pet & Play (3" air spacing) – styles vary

PROFUSION WELDED STEEL



All Montage fence panels are fabricated using Ameristar's ProFusion welding process. This technique combines laser and fusion technology to create a virtually invisible structural connection at every picket to rail intersection. Unlike typical aluminum fence systems that are held together with unsightly screws, the ProFusion weld used with Montage promotes a "good neighbor" profile with sleek lines and no exposed picket to rail fasteners. When compared to aluminum fencing, Montage's welded steel construction is unmatched in strength and durability.



E-COAT™ PROTECTIVE FINISH

Montage galvanized steel framework is subjected to a multi-stage pre-treatment/wash (with zinc phosphate), followed by a duplex cathodic electrocoat system consisting of an epoxy primer, which significantly increases corrosion protection, and an acrylic topcoat, which provides the protection necessary to withstand adverse weathering effects. This process results in years of maintenance-free ownership.



20 YEAR LIMITED WARRANTY

The Montage families of fencing products are manufactured from superior quality materials by skilled craftsmen with the highest standards of workmanship in the industry. Ameristar is confident in offering Montage with a 20 year limited warranty.



DOMESTIC MANUFACTURING

Ameristar is committed to providing products that are manufactured in the USA. We have made significant investments in technology, process improvement, and employee training in an effort to secure American jobs and combat inferior import products.

#DMP | REVISED 05/2014



FENCE PRODUCTS

TO PLACE YOUR ORDER CALL 888-333-3422

VISIT AMERISTARFENCE.COM







MONTAGE PLUS[®]

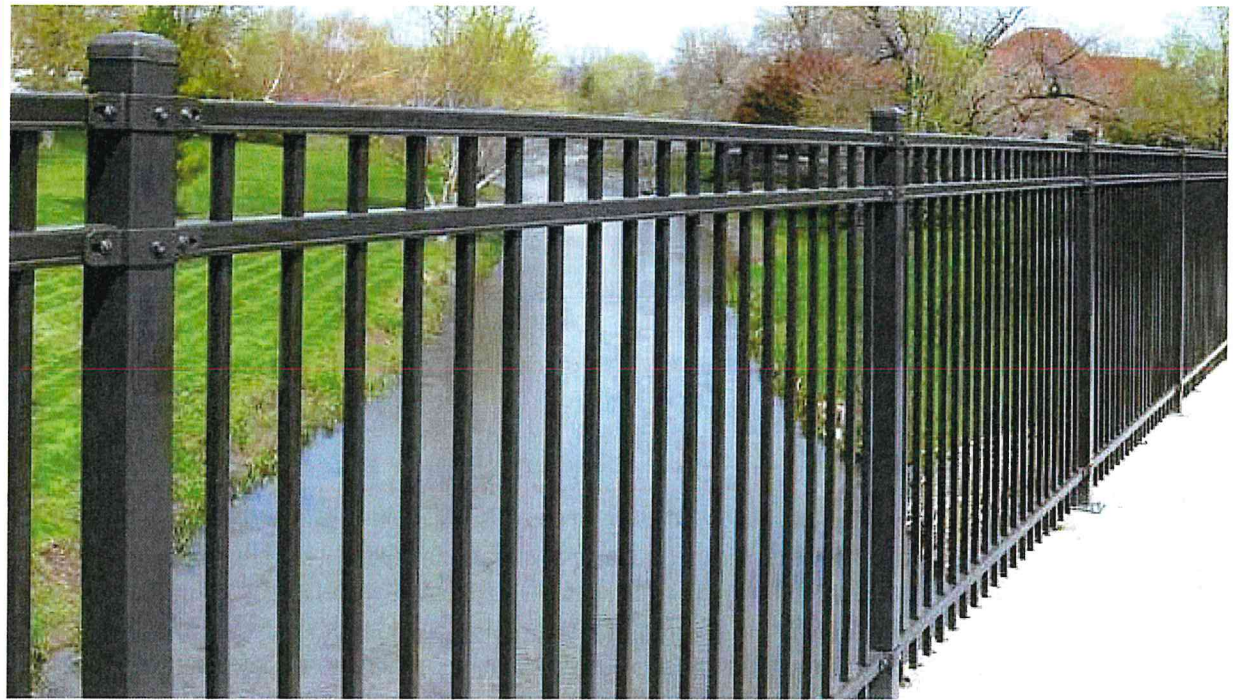

ORNAMENTAL STEEL FENCE

Montage Plus ornamental steel fence has the *versatility to fit many different project applications*. With its ability to *traverse varying grades*, variety of *distinct product styles* and unmatched coating performance, Montage Plus is the *preferred choice for ornamental fence*.

PRIMARY APPLICATIONS

- **Commercial Developments**
- **Self Storage**
- **Apartments (Multi-Family)**
- **Parks & Recreation**
- **Schools & Universities**



FENCE PRODUCTS

AMERISTARPERIMETER.COM | 888-333-3422

Experience a safer and more open world

AMERISTAR[®]

ASSA ABLOY

MONTAGE PLUS[®]

ORNAMENTAL STEEL FENCE

.75"sq x 18ga PICKETS | 1.4375" x 1.5" x 14ga RAILS | 2.5"sq x 16ga POSTS

Each picket is precisely welded at each rail intersection providing all-terrain flexibility and aesthetics.

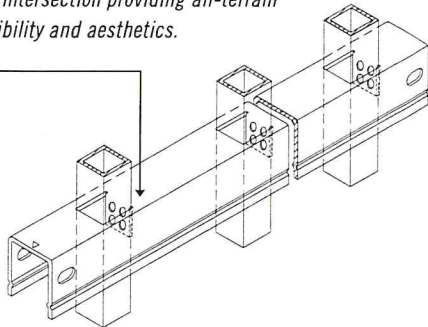

STYLE OPTIONS

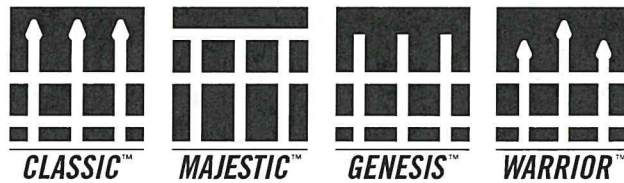

Also available in Pool, Pet & Play (3" air spacing) – styles vary

PROFUSION WELDED STEEL



All Montage fence panels are fabricated using Ameristar's ProFusion welding process. This technique combines laser and fusion technology to create a virtually invisible structural connection at every picket to rail intersection. Unlike typical aluminum fence systems that are held together with unsightly screws, the ProFusion weld used with Montage promotes a "good neighbor" profile with sleek lines and no exposed picket to rail fasteners. When compared to aluminum fencing, Montage's welded steel construction is unmatched in strength and durability.



E-COAT™ PROTECTIVE FINISH

Montage galvanized steel framework is subjected to a multi-stage pre-treatment/wash (with zinc phosphate), followed by a duplex cathodic electrocoat system consisting of an epoxy primer, which significantly increases corrosion protection, and an acrylic topcoat, which provides the protection necessary to withstand adverse weathering effects. This process results in years of maintenance-free ownership.



20 YEAR LIMITED WARRANTY

The Montage families of fencing products are manufactured from superior quality materials by skilled craftsmen with the highest standards of workmanship in the industry. Ameristar is confident in offering Montage with a 20 year limited warranty.



DOMESTIC MANUFACTURING

Ameristar is committed to providing products that are manufactured in the USA. We have made significant investments in technology, process improvement, and employee training in an effort to secure American jobs and combat inferior import products.



FENCE PRODUCTS

TO PLACE YOUR ORDER CALL 888-333-3422

VISIT AMERISTARPERIMETER.COM

MONTAGE PLUS® | 2 & 3-RAIL OPTIONS | 3" & 4" AIR-SPACE OPTIONS

STANDARD BOTTOM & FLUSH BOTTOM OPTIONS AVAILABLE

PATENT NUMBERS: 7071439, 7282659, 7621510, 7896318,
 7980534, 8523150, 9840854, 10538939

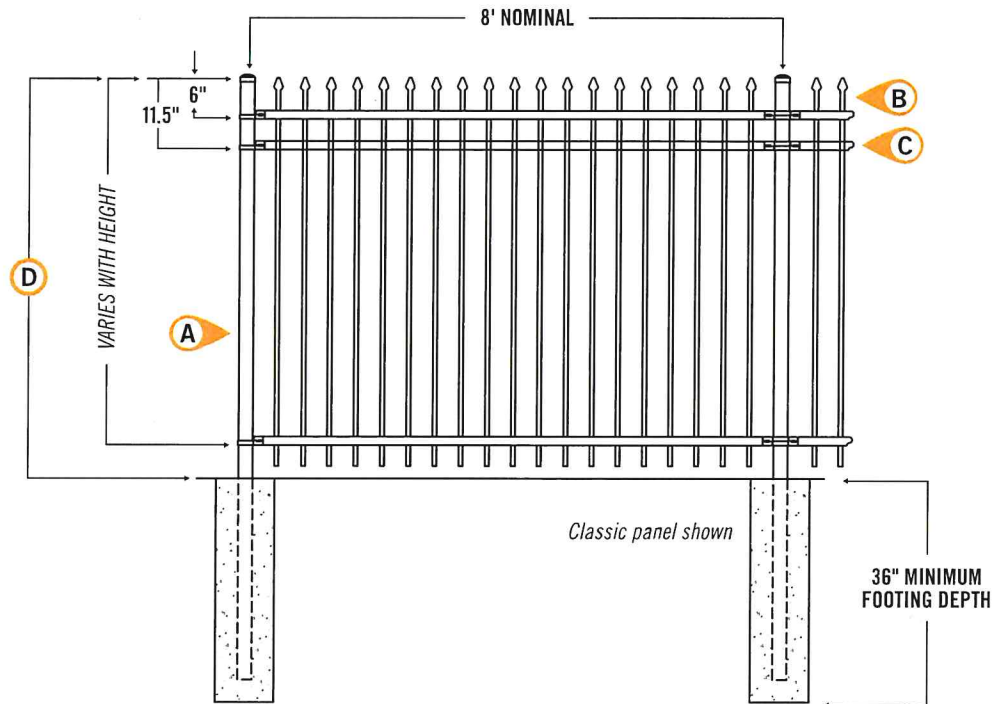

- Ⓐ 2.5"sq x 16ga POSTS
- Ⓑ 0.75"sq x 18ga PICKETS
- Ⓒ 1.4375"w x 1.5"h x 14ga RAILS
- Ⓓ 3', 3.5', 4', 4.5', 5' & 6' PANEL HEIGHTS

Refer to construction specification & tables within this section for recommended post space by bracket type

Alternative 16' x 4' L

MONTAGE PLUS® | 2-RAIL PANELS | 4" AIR GAP

STANDARD BOTTOM | 8' PANEL LENGTH (92" actual width) | 19 PICKETS PER PANEL | 30 PANELS PER PALLET

PANEL	ITEM NUMBER	WEIGHT	STOCKING
3'	1R☒Ⓞ234	42 lbs	☉
3.5'	1R☒Ⓞ240	48 lbs	☉
4'	1R☒Ⓞ246	52 lbs	MB
5'	1R☒Ⓞ258	61 lbs	☉
6'	1R☒Ⓞ270	70 lbs	CB MB GB

☒ = FENCE STYLES AVAILABLE | **C** = Classic **M** = Majestic **G** = Genesis
W = Warrior

Ⓞ = COLOR OPTIONS AVAILABLE | **B** = Black

☉ = NON-STOCKED PRODUCT
 For details, see Ameristar's Sales Policy in the catalog guide.

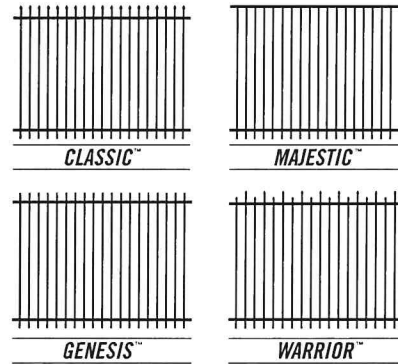

Notes: Genesis panels are packaged with BLACK picket plugs.

MONTAGE PLUS® | 2-RAIL PANELS | 3" AIR GAP

STANDARD BOTTOM | 8' PANEL LENGTH (92" actual width) | 24 PICKETS PER PANEL | 30 PANELS PER PALLET

PANEL	ITEM NUMBER	WEIGHT	STOCKING
3'	1R☒Ⓞ234-3	49 lbs	☉
3.5'	1R☒Ⓞ240-3	55 lbs	☉
4'	1R☒Ⓞ246-3	61 lbs	☉
5'	1R☒Ⓞ258-3	72 lbs	☉
6'	1R☒Ⓞ270-3	83 lbs	☉

☒ = FENCE STYLES AVAILABLE | **C** = Classic **M** = Majestic **G** = Gemini

Ⓞ = COLOR OPTIONS AVAILABLE | **B** = Black

☉ = NON-STOCKED PRODUCT
 For details, see Ameristar's Sales Policy in the catalog guide.

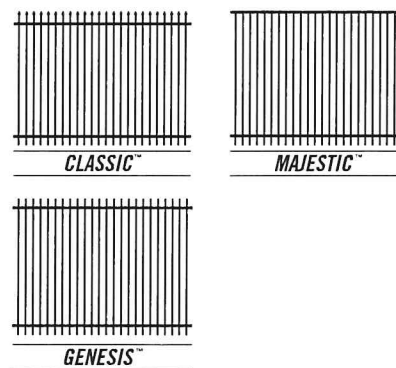

Notes: Genesis panels are packaged with BLACK picket plugs.

MONTAGE PLUS® | 2-RAIL PANELS | 4" AIR GAP

FLUSH BOTTOM | 8' PANEL LENGTH (92" actual width) | 19 PICKETS PER PANEL | 30 PANELS PER PALLET

PANEL	ITEM NUMBER	WEIGHT	STOCKING
3'	1R☒Ⓞ234F	42 lbs	☉
3.5'	1R☒Ⓞ240F	48 lbs	☉
4'	1R☒Ⓞ246F	52 lbs	MB
5'	1R☒Ⓞ258F	61 lbs	☉
6'	1R☒Ⓞ270F	70 lbs	MB

☒ = FENCE STYLES AVAILABLE | **C** = Classic **M** = Majestic **G** = Genesis
W = Warrior

Ⓞ = COLOR OPTIONS AVAILABLE | **B** = Black

☉ = NON-STOCKED PRODUCT

For details, see Ameristar's Sales Policy in the catalog guide.

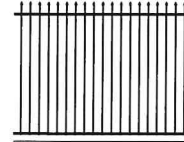

CLASSIC™

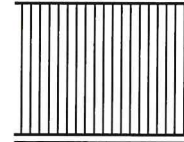

MAJESTIC™

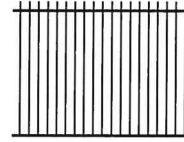

GENESIS™

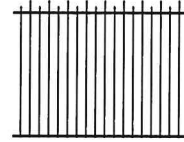

WARRIOR™

Notes: Genesis panels are packaged with BLACK picket plugs.

MONTAGE PLUS® | 2-RAIL PANELS | 3" AIR GAP

FLUSH BOTTOM | 8' PANEL LENGTH (92" actual width) | 24 PICKETS PER PANEL | 30 PANELS PER PALLET

PANEL	ITEM NUMBER	WEIGHT	STOCKING
3'	1R☒Ⓞ234F-3	49 lbs	☉
3.5'	1R☒Ⓞ240F-3	55 lbs	☉
4'	1R☒Ⓞ246F-3	61 lbs	☉
5'	1R☒Ⓞ258F-3	72 lbs	☉
6'	1R☒Ⓞ270F-3	83 lbs	☉

☒ = FENCE STYLES AVAILABLE | **C** = Classic **M** = Majestic **G** = Gemini

Ⓞ = COLOR OPTIONS AVAILABLE | **B** = Black

☉ = NON-STOCKED PRODUCT

For details, see Ameristar's Sales Policy in the catalog guide.

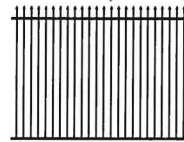

CLASSIC™

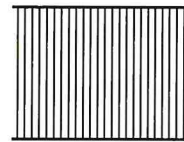

MAJESTIC™

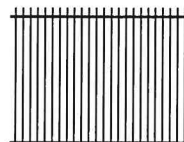

GENESIS™

Notes: Genesis panels are packaged with BLACK picket plugs.

MONTAGE PLUS® | 3-RAIL PANELS | 4" AIR GAP

STANDARD BOTTOM | 8' PANEL LENGTH (92" actual width) | 19 PICKETS PER PANEL | 30 PANELS PER PALLET

PANEL	ITEM NUMBER	WEIGHT	STOCKING
3'	1R☒☉334	50 lbs	MB
3.5'	1R☒☉340	56 lbs	MB
4'	1R☒☉346	60 lbs	CB MB GB
5'	1R☒☉358	69 lbs	CB MB GB
6'	1R☒☉370	78 lbs	CB MB GB

☒ = FENCE STYLES AVAILABLE | **C** = Classic | **M** = Majestic | **G** = Genesis
W = Warrior

☉ = COLOR OPTIONS AVAILABLE | **B** = Black

☉ = NON-STOCKED PRODUCT

For details, see Ameristar's Sales Policy in the catalog guide.

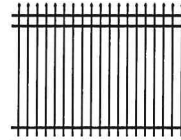

CLASSIC™

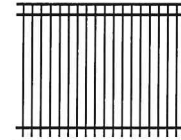

MAJESTIC™

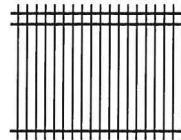

GENESIS™

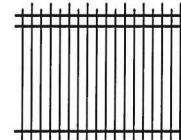

WARRIOR™

Notes: Genesis panels are packaged with BLACK picket plugs.

MONTAGE PLUS® | 3-RAIL PANELS | 3" AIR GAP

STANDARD BOTTOM | 8' PANEL LENGTH (92" actual width) | 24 PICKETS PER PANEL | 30 PANELS PER PALLET

PANEL	ITEM NUMBER	WEIGHT	STOCKING
3'	1R☒☉334-3	56 lbs	☉
3.5'	1R☒☉340-3	63 lbs	☉
4'	1R☒☉346-3	69 lbs	☉
5'	1R☒☉358-3	80 lbs	☉
6'	1R☒☉370-3	91 lbs	☉

☒ = FENCE STYLES AVAILABLE | **C** = Classic | **M** = Majestic | **G** = Genesis

☉ = COLOR OPTIONS AVAILABLE | **B** = Black

☉ = NON-STOCKED PRODUCT

For details, see Ameristar's Sales Policy in the catalog guide.

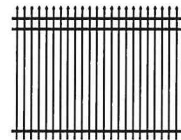

CLASSIC™

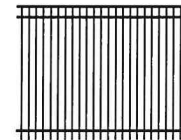

MAJESTIC™

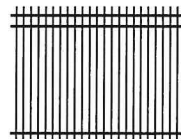

GENESIS™

Notes: Genesis panels are packaged with BLACK picket plugs.

creative 20-14-12

MONTAGE PLUS[®] | 3-RAIL PANELS | 4" AIR GAP

FLUSH BOTTOM | 8' PANEL LENGTH (92" actual width) | 19 PICKETS PER PANEL | 30 PANELS PER PALLET

PANEL	ITEM NUMBER	WEIGHT	STOCKING
3'	1R☒☉334F	50 lbs	☉
3.5'	1R☒☉340F	56 lbs	☉
4'	1R☒☉346F	60 lbs	<u>MB</u>
4.5'	1RM☉354F	65 lbs	☉
5'	1R☒☉358F	69 lbs	☉
6'	1R☒☉370F	78 lbs	<u>MB</u>

☒ = FENCE STYLES AVAILABLE | C = Classic M = Majestic G = Genesis
W = Warrior

☉ = COLOR OPTIONS AVAILABLE | B = Black

☉ = NON-STOCKED PRODUCT

For details, see Ameristar's Sales Policy in the catalog guide.

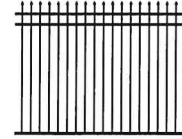

CLASSIC™

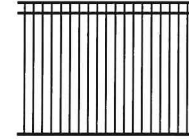

MAJESTIC™

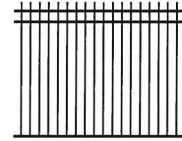

GENESIS™

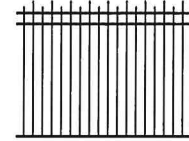

WARRIOR™

Notes: Genesis panels are packaged with BLACK picket plugs.

MONTAGE PLUS[®] | 3-RAIL PANELS | 3" AIR GAP

FLUSH BOTTOM | 8' PANEL LENGTH (92" actual width) | 24 PICKETS PER PANEL | 30 PANELS PER PALLET

PANEL	ITEM NUMBER	WEIGHT	STOCKING
3'	1R☒☉334F-3	56 lbs	☉
3.5'	1R☒☉340F-3	63 lbs	☉
4'	1R☒☉346F-3	69 lbs	☉
4.5'	1RM☉354F-3	75 lbs	☉
5'	1R☒☉358F-3	80 lbs	☉
6'	1R☒☉370F-3	91 lbs	<u>MB</u>

☒ = FENCE STYLES AVAILABLE | C = Classic M = Majestic G = Genesis

☉ = COLOR OPTIONS AVAILABLE | B = Black

☉ = NON-STOCKED PRODUCT

For details, see Ameristar's Sales Policy in the catalog guide.

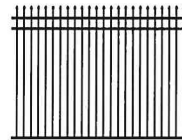

CLASSIC™

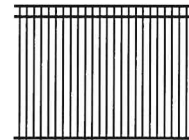

MAJESTIC™

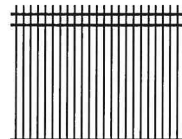

GENESIS™

Notes: Genesis panels are packaged with BLACK picket plugs.

Effective 3-1-18

MONTAGE PLUS® | BRACKETS

AVAILABLE IN BAG QUANTITIES ONLY

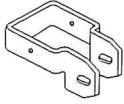

DESCRIPTION	SIZE	ITEM NUMBER	BAG QTY	BOX QTY	WEIGHT
Universal Boulevard Bracket	2.5"	B⊗ 112SR	2	40 bags	.15 lbs
	2"	B⊗ 117SR	2	60 bags	.15 lbs
<i>Bags packaged with: #14 x .75" self-drilling screws .25" x 2" carriage bolts .25" tri groove security nuts</i>					



Line Bracket	2.5"	B⊗ 114SR	2	40 bags	.84 lbs
	2"	B⊗ 116SR	2	50 bags	.72 lbs
<i>Bags packaged with: #14 x .75" self-drilling screws .25" x 2" carriage bolts .25" tri groove security nuts</i>					

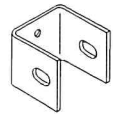

Flat Mount Bracket	n/a	B⊗ 111SR	2	80 bags	.27 lbs
<i>Bags packaged with: #14 x .75" self-drilling screws .25" x 2" carriage bolts .25" tri groove security nuts</i>					

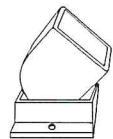

Swivel Bracket	n/a	B⊗ 113	2	40 bags	.20 lbs
<i>Bags packaged with: #10 x .75" self-drilling screws #10 x .625" Phillips flat head screws</i>					

⊗ = COLOR OPTIONS AVAILABLE | B = Black

MONTAGE PLUS® | FINIALS & ADORNMENTS

FINIALS & PICKET PLUGS FOR GENESIS PANELS ONLY | ADORNMENTS FOR 4" AIR-SPACE ONLY



QUAD FLARE
 .75" / .15 lbs
 A⊗ 518



TRIAD
 .75" / .15 lbs
 A⊗ 520R



ROYALTY
 .75" / .21 lbs
 A⊗ 525

.625" PRESS FIT PICKET FINIALS

- » 19 finials required per panel with 4" air-space
- » 24 finials required per panel with a 3" air-space

⊗ = COLOR OPTIONS AVAILABLE | B = Black

NOTE: Picket plugs are available in bag quantities only / 19 plugs per bag; Item number = PB7519P

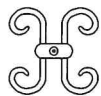

BUTTERFLY SCROLL
 .75" / .7 lbs
 H⊗ 506NR1



DOUBLE RINGS
 .75" / .2 lbs
 A⊗ 112

MONTAGE PLUS PANEL ADORNMENTS

- » Fit in between / on the face of top rails on 3-rail panels
- » #10 x .75" self-drilling screws included
- » 9 adornments required per panel
- » Die cast aluminum

⊗ = COLOR OPTIONS AVAILABLE | B = Black

EXHIBIT 30-10-22

MONTAGE PLUS® | FASTENERS

AVAILABLE IN BAG QUANTITIES ONLY (Phillips head screws sold individually)

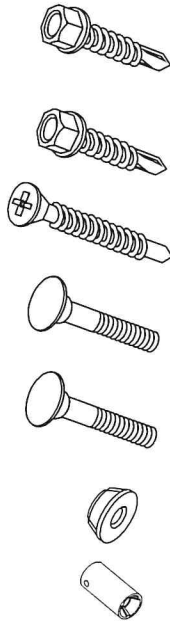

DESCRIPTION	ITEM NUMBER / BLACK	BAG QTY	WEIGHT EA
#14 x .75" Tek Screw <i>Steel hex head self-drilling screws for attaching Montage Plus brackets & adornments</i>	H⊗524P-50	50	.6 lbs
#10 x .75" Tek Screw <i>Steel hex head self-drilling screws for attaching Montage Plus brackets & adornments</i>	H⊗539P-50	50	.35 lbs
#10 x .625" Phillips Head Tek Screw <i>Steel flat head screws for setting angle on Montage Plus swivel brackets</i>	H⊗519P	1	.005 lbs
.25" x 2" Carriage Bolt <i>Steel carriage bolt for Montage Plus brackets</i>	H⊗516P	1	.027 lbs
.25"-20 x 2-1/2" Carriage Bolt 18-8 <i>Steel carriage bolt for Montage Plus brackets</i>	2-0068-⊠P	1	.032 lbs
.25" Tri Groove Security Nut	3-0033-⊠P-20	20	.3 lbs
Fastener Socket	6-0058PFG	1	.06 lbs
One-Way Screw Remover	33246P	1	.10 lbs

⊗ = COLOR OPTIONS AVAILABLE | B = Black

⊠ = COLOR OPTIONS AVAILABLE | 1 = Black

MONTAGE PLUS® | CUSTOM FINISHES

WARRANTY ON CUT COMPONENTS VOID WITHOUT PROPER TOUCH-UP APPLICATION*

*For details & the guidelines for the proper 3-step process, see Ameristar's Sales Policy in the catalog guide

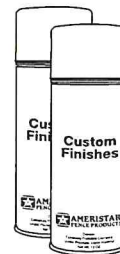
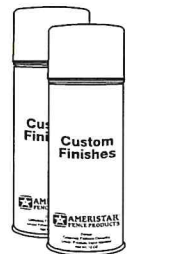
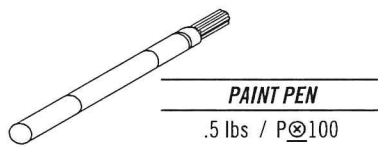

⊗ = COLOR OPTIONS AVAILABLE | B = Black

Effective 08-14-21

MONTAGE PLUS® | STEEL SQUARE POSTS

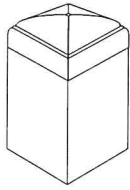

STEEL POSTS

	POST LENGTH	ITEM NUMBER	WEIGHT
2.5"sq. x 16ga.	6'	WPⓧ 25072	12 lbs
	7'	WPⓧ 25084	14 lbs
	8'	WPⓧ 25096	16 lbs
	9'	WPⓧ 25108	18 lbs
2.5"sq. x 14ga.	8'	WPⓧ 25096-14	20 lbs
	9'	WPⓧ 25108-14	23 lbs
	10'	WPⓧ 25120-14	25 lbs
	11'	WPⓧ 25132-14	27 lbs
2.5"sq. x 12ga.	7'	Pⓧ 25084	22 lbs
	8'	Pⓧ 25096	26 lbs
	9'	Pⓧ 25108	28 lbs
	10'	Pⓧ 25120	31 lbs
	11'	Pⓧ 25132	35 lbs
3"sq. x 12ga.	5'	Pⓧ 30060	20 lbs
	6'	Pⓧ 30072	24 lbs
	7'	Pⓧ 30084	30 lbs
	8'	Pⓧ 30096	34 lbs
	9'	Pⓧ 30108	39 lbs
	10'	Pⓧ 30120	43 lbs
4"sq. x 11ga.	6'	Pⓧ 40072	39 lbs
	7'	Pⓧ 40084	47 lbs
	8'	Pⓧ 40096	54 lbs
	9'	Pⓧ 40108	61 lbs
	10'	Pⓧ 40120	67 lbs
6"sq. x .1875" wall	7'	Pⓧ 60084	102 lbs
	8'	Pⓧ 60096	116 lbs
	9'	Pⓧ 60108	131 lbs
	10'	Pⓧ 60120	145 lbs
8"sq. x .25" wall	9'	Pⓧ 80108	233 lbs
	10'	Pⓧ 80120	259 lbs

ⓧ = COLOR OPTIONS AVAILABLE | B = Black

NOTE: In locations subject to freezing temperatures, where posts are grouted into core-drilled holes, a .25" diameter hole should be drilled into the post approximately .5" above the elevation to allow for drainage of ground water build-up. The drilled hole must be wiped clean and be dry prior to applying Ameristar zinc primer and color finish.

effective 08-13-21

MONTAGE PLUS[®] | STEEL PLATED SQUARE POSTS

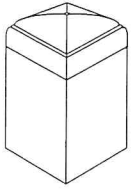

STEEL POSTS

POST LENGTH	PLATE SIZE	ITEM NUMBER	WEIGHT
2.5"sq. x 12ga.	4'	5" sq. x .25" / .5625 holes (8833G) PⓈ25048P	16 lbs
	5'	5" sq. x .25" / .5625 holes (8833G) PⓈ25060P	19 lbs
	6'	5" sq. x .25" / .5625 holes (8833G) PⓈ25072P	22 lbs
3"sq. x 12ga.	4'	6" sq. x .25" / .5625 holes (5003G) PⓈ30048P	20 lbs
	5'	6" sq. x .25" / .5625 holes (5003G) PⓈ30060P	24 lbs
	6'	6" sq. x .25" / .5625 holes (5003G) PⓈ30072P	30 lbs
4"sq. x 11ga.	4'	8" sq. x .375" / .5625 holes (8876G) PⓈ40048P	33 lbs
	5'	8" sq. x .375" / .5625 holes (8876G) PⓈ40060P	39 lbs
	6'	8" sq. x .375" / .5625 holes (8876G) PⓈ40072P	47 lbs

Ⓢ = COLOR OPTIONS AVAILABLE | B = Black

NOTE: Posts used with Majestic may require an additional 1" longer than the panel or gate height, depending on the grade elevation.

MONTAGE PLUS[®] | POST CAPS

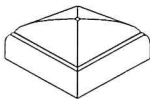

STANDARD FLAT CAP
Steel

CAP SIZE	ITEM NUMBER	WEIGHT
1.75" sq	AⓈ505P	.1 lbs
2" sq	AⓈ506	.2 lbs
2.5" sq	AⓈ507	.3 lbs
3" sq	AⓈ508	.3 lbs
4" sq	AⓈ509	.4 lbs
6" sq	AⓈ515	.8 lbs
8" sq	AⓈ801	2 lbs



BALL CAP
Aluminum

CAP SIZE	ITEM NUMBER	WEIGHT
2" sq	HⓈ508R	.7 lbs
2.5" sq	AⓈ513R1	.7 lbs
3" sq	AⓈ516R1	.8 lbs
4" sq	AⓈ517	2 lbs
6" sq	AⓈ521	8 lbs

Ⓢ = COLOR OPTIONS AVAILABLE | B = Black

Effective 06-16-22

MONTAGE PLUS® | CONSTRUCTION SPECIFICATION 32 31 19

STEEL ORNAMENTAL FENCE SYSTEM – FUSION WELDED & RACKABLE

PART 1 - GENERAL

1.01 WORK INCLUDED

The contractor shall provide all labor, materials and appurtenances necessary for installation of the welded ornamental steel fence system defined herein at (*specify project site*).

1.02 RELATED WORK

Section _____ - Earthwork

Section _____ - Concrete

1.03 SYSTEM DESCRIPTION

The manufacturer shall supply a total fence system of (*specify Montage Plus® standard picket space or Montage Plus® Pool, Pet & Play® 3" air space*) Welded and Rackable (ATF – All Terrain Flexibility) Ornamental Steel (*for standard picket space, specify Classic™, Majestic™, Genesis™, or Warrior™; for 3" air space, specify Classic™, Majestic™, or Genesis™*) design. The system shall include all components (i.e., panels, posts, gates and hardware) required.

1.04 QUALITY ASSURANCE

The contractor shall provide laborers and supervisors who are thoroughly familiar with the type of construction involved and materials and techniques specified.

1.05 REFERENCES

ASTM A653/A653M - Standard Specification for Steel Sheet, Zinc-Coated (Galvanized) or Zinc-Iron Alloy Coated (Galvannealed) by the Hot-Dip Process.

ASTM B117 - Practice for Operating Salt-Spray (Fog) Apparatus.

ASTM D523 - Test Method for Specular Gloss

ASTM D714 - Test Method for Evaluating Degree of Blistering in Paint.

ASTM D822 - Practice for Conducting Tests on Paint and Related Coatings and Materials using Filtered Open-Flame Carbon-Arc Light and Water Exposure Apparatus.

ASTM D1654 - Test Method for Evaluation of Painted or Coated Specimens Subjected to Corrosive Environments.

ASTM D2244 - Test Method for Calculation of Color Differences from Instrumentally Measured Color Coordinates.

ASTM D2794 - Test Method for Resistance of Organic Coatings to the Effects of Rapid Deformation (Impact).

ASTM D3359 - Test Method for Measuring Adhesion by Tape Test.

ASTM F2408 - Ornamental Fences Employing Galvanized Steel Tubular Pickets.

IBC 2018 1607.8.1 - Handrails and Guards

1.06 SUBMITTAL

The manufacturer's literature shall be submitted prior to installation.

1.07 PRODUCT HANDLING AND STORAGE

Upon receipt at the job site, all materials shall be checked to ensure that no damage occurred during shipping or handling. Materials shall be stored in such a manner to ensure proper ventilation and drainage, and to protect against damage, weather, vandalism and theft..

1.08 PRODUCT WARRANTY

- A. All structural fence components (i.e. rails, pickets, and posts) shall be warranted within specified limitations, by the manufacturer for a period of 20 years from date of original purchase. Warranty shall cover any defects in material finish, including cracking, peeling, chipping, blistering or corroding.
- B. Reimbursement for labor necessary to restore or replace components that have been found to be defective under the terms of manufactures warranty shall be guaranteed for five (5) years from date of original purchase.

PART 2 - MATERIALS

2.01 MANUFACTURER

The fence system shall conform to (*specify Montage Plus standard picket space or Montage Plus Pool, Pet & Play 3" air space*) Welded and Rackable (ATF – All Terrain Flexibility) Ornamental Steel, (*for standard picket space, specify Classic, Majestic, Genesis or Warrior; for 3" air space, specify Classic, Majestic, or Genesis*) design, (*specify extended picket or flush*) bottom rail treatment, (*specify 2-Rail, 3-Rail or 3-Rail with Double Rings*) style manufactured by Ameristar Fence Products, Inc., in Tulsa, Oklahoma.

2.02 MATERIAL

- A. Steel material for fence panels and posts shall conform to the requirements of ASTM A653/A653M, with a minimum yield strength of 45,000 psi (310 MPa) and a minimum zinc (hot-dip galvanized) coating weight of 0.60 oz/ft² (184 g/m²), Coating Designation G-60.
- B. Material for pickets shall be 3/4" square x 18 Ga. tubing. The rails shall be steel channel, 1.5" x 1.4375" x 14 Ga. Picket holes in the rail shall be spaced (*specify 4.675" o.c. for standard picket space or 3.500" o.c. for 3" air space*). Fence posts and gate posts shall meet the minimum size requirements of Table 1.

2.03 FABRICATION

- A. Pickets, rails and posts shall be pre-cut to specified lengths. Rails shall be pre-punched to accept pickets.
- B. Pickets shall be inserted into the pre-punched holes in the rails and shall be aligned to standard spacing using a specially calibrated alignment fixture. The aligned pickets and rails shall be joined at each picket-to-rail intersection

Sheet 32 31 19 01

MONTAGE PLUS® | CONSTRUCTION SPECIFICATION 32 31 19

STEEL ORNAMENTAL FENCE SYSTEM – FUSION WELDED & RACKABLE

by Ameristar's proprietary fusion welding process, thus completing the rigid panel assembly (Note: The process produces a virtually seamless, spatter-free good-neighbor appearance, equally attractive from either side of the panel).

- C. The manufactured panels and posts shall be subjected to an inline electrode position coating (E-Coat) process consisting of a multi-stage pretreatment/wash, followed by a duplex application of an epoxy primer and an acrylic topcoat. The minimum cumulative coating thickness of epoxy and acrylic shall be 2 mils (0.058 mm). The color shall be Black. The coated panels and posts shall be capable of meeting the performance requirements for each quality characteristic shown in Table 2 (Note: The requirements in Table 2 meet or exceed the coating performance criteria of ASTM F2408).
- D. The manufactured fence system shall be capable of meeting the vertical load, horizontal load, and infill performance requirements for Commercial weight fences under ASTM F2408.
- E. Classic, Majestic, Genesis & Warrior styles with 3 & 4-rail configurations shall meet IBC compliance. Panel, post and bracket assemblies shall be subjected to structural performance testing according to Chapter 17 – Structural Tests and Special Inspections – International Building Code (IBC) 2018. Physical testing to be completed by accredited third party testing facility. Completed assembly shall demonstrate loading capacity of 2.5 times prescribed design loads found in section 1607.8.1, 1607.8.1.1 and 1607.8.1.2 of IBC 2018 for Handrails and Guards. IBC compliant fence system requirements detailed within Table 4.
- F. Gates with an out-to-out leaf dimension less than and including 72 inches shall be fabricated using Montage Plus ornamental panel material and 1-3/4" sq. x 14ga. gate ends. Gate leaves greater than 72 inches shall be fabricated using ForeRunner rails, 17 gauge pickets, intermediate uprights, gussets and 1-3/4" sq. x 14ga. gate ends. All rail and upright intersections shall be joined by welding. All picket and rail intersections shall also be joined by welding.

PART 3 - EXECUTION

3.01 PREPARATION

All new installation shall be laid out by the contractor in accordance with the construction plans.

3.02 INSTALLATION

Fence post shall be spaced according to Table 3, plus or minus ¼". For installations that must be raked to follow sloping grades, the post spacing dimension must be measured along the grade. Fence panels shall be attached to posts with brackets supplied by the manufacturer. Posts shall be set in concrete footers having a minimum depth of 36" (Note: In some cases, local restrictions of freezing weather conditions may require a greater depth). The "Earthwork" and "Concrete" sections of this specification shall govern material requirements for the concrete footer. Posts setting by other methods such as plated posts or grouted core-drilled footers are permissible only if shown by engineering analysis to be sufficient in strength for the intended application.

3.03 FENCE INSTALLATION MAINTENANCE

When cutting/drilling rails or posts adhere to the following steps to seal the exposed steel surfaces; 1) Remove all metal shavings from cut area. 2) Apply zinc-rich primer to thoroughly cover cut edge and/or drilled hole; let dry. 3) Apply 2 coats of custom finish paint matching fence color. Failure to seal exposed surfaces per steps 1-3 above will negate warranty. Ameristar spray cans or paint pens shall be used to prime and finish exposed surfaces; it is recommended that paint pens be used to prevent overspray. Use of non-Ameristar parts or components will negate the manufactures' warranty.

3.04 GATE INSTALLATION

Gate posts shall be spaced according to the manufacturers' gate drawings, dependent on standard out-to-out gate leaf dimensions and gate hardware selected. Type and quantity of gate hinges shall be based on the application; weight, height, and number of gate cycles. The manufacturers' gate drawings shall identify the necessary gate hardware required for the application. Gate hardware shall be provided by the manufacture of the gate and shall be installed per manufacturer's recommendations.

3.05 CLEANING

The contractor shall clean the jobsite of excess materials; post-hole excavations shall be scattered uniformly away from posts.

SEE REFERENCED TABLES ON THE FOLLOWING PAGE

CS-19-12

MONTAGE PLUS® | CONSTRUCTION SPECIFICATION 32 31 19

WELDED ORNAMENTAL STEEL FENCE PRODUCTS

TABLE 1 - MINIMUM SIZES FOR MONTAGE PLUS POSTS		
FENCE POSTS	PANEL HEIGHTS	
2.5" x 16 ga.	up to & including 6' heights	
GATE LEAF	GATE HEIGHT	
	up to & including 4'	over 4' up to & including 6'
up to 4'	2.5" x 16 gauge	2.5" x 14 gauge
4'1" to 6'	3" x 12 gauge	3" x 12 gauge
6'1" to 10'	4" x 11 gauge	4" x 11 gauge
10'1" to 16'	6" x 3/16" wall	6" x 3/16" wall

TABLE 2 - COATING PERFORMANCE REQUIREMENTS		
QUALITY CHARACTERISTICS	ASTM TEST METHOD	PERFORMANCE REQUIREMENTS
ADHESION	D3359 – METHOD B	Adhesion (Retention of Coating) over 90% of test area (Tape and knife test).
CORROSION RESISTANCE	B117, D714, D1654	Corrosion Resistance over 1,500 hours (Scribed per D1654; failure mode is accumulation of 1/8" coating loss from scribe or medium #8 blisters).
IMPACT RESISTANCE	D2794	Impact Resistance over 60-inch lb. (Forward impact using 0.625" ball).
WEATHERING RESISTANCE	D822 D2244, D523 (60° method)	Weathering Resistance over 1,000 hours (Failure mode is 60% loss of gloss or color variance of more than 3 delta-E color units).

TABLE 3 - MONTAGE PLUS POST SPACING BY BRACKET TYPE						
SPAN	Classic, Genesis, Majestic & Warrior / 8' nominal (91.95" rail)					
POST SIZE	2-1/2"	2-1/2"	2-1/2"	3"	2-1/2"	3"
BRACKET TYPE	Montage Plus Universal (BB112)	Montage Plus Line Blvd. (BB114)	Montage Plus Flat Mount (BB111)		Montage Plus Swivel (BB113)*	
POST SETTINGS ± 1/4" O.C.	95"	95"	95"	95-1/2"	*95"	*95-1/2"
*Note: When using BB113 swivel brackets on either or both ends of a panel installation, care must be taken to ensure the spacing between post and adjoining pickets meets applicable codes. This will require trimming one or both ends of the panel.						

TABLE 4 - MONTAGE PLUS - IBC COMPLIANT SYSTEM REQUIREMENTS				
PANEL OPTIONS		POST OPTIONS		BRACKETS OPTIONS
STYLES	RAIL CONFIGURATION	STEEL POST OPTIONS	POST PLATE OPTIONS (ANCHORAGE BY OTHERS)	LINE BOULEVARD BRACKETS
CLASSIC	3-RAIL & 4-RAIL	2.5" SQ X 14GA	8" X 8" X 3/8" - FOR 2.5" POSTS	END BOULEVARD BRACKETS
MAJESTIC		3" SQ X 12GA	10" X 10" X 3/8" - FOR 3" POSTS	CORNER BOULEVARD BRACKETS
GENESIS		4" SQ X 12GA		*FLAT MOUNT BRACKETS
WARRIOR			*NOTE: FLAT MOUNT BRACKETS REQUIRE A THRU-BOLT INSTALLATION	
Panel, post, and bracket assemblies shall be subjected to structural performance testing according to Chapter 17 - Structural Tests and Special Inspections - International Building Code (IBC) 2018. Physical testing to be completed by accredited third party testing facility. Completed assembly shall demonstrate loading capacity of 2.5 times prescribed design loads found in section 1607.8.1, 1607.8.1.1 and 1607.8.1.2 of IBC 2018 for Handrails and Guards.				

MONTAGE PLUS® | LIMITED WARRANTY

WELDED ORNAMENTAL FENCE

Ameristar's Montage Plus® welded ornamental fences are manufactured from the highest quality materials by skilled craftsmen to meet the highest standards of workmanship in the industry. Galvanized steel framework is subjected to a multi-stage pretreatment/wash (with zinc phosphate), followed by a duplex cathodic electro-coat system consisting of an epoxy primer, which significantly increases corrosion protection, and an acrylic liquid topcoat, which provides the protection necessary to withstand adverse weathering effects.

The electro-coated surface on all Montage Plus welded ornamental panels and posts are guaranteed under normal and intended usage, against cracking, peeling, chipping, blistering or corroding commencing with the original purchase date and extending according to the applications defined in the table below. Normal and intended usage does not include physical damage, abrasion, or heavy salt spray exposure to the protective coating.

The following acts and/or omissions will void the subject warranty:

- Damage to the product caused by the property owner by use of landscape, gardening equipment, chemicals that may cause damage, and/or water sprinklers with high mineral content;
- Damage caused by adhesion of chicken wire, chain link mesh, welded wire, or other similar substance to the product;
- Damage caused by allowing plant life of any sort to grow directly upon or in contact with any portion of the product or sap from trees;
- Any alteration to the product itself by the property owner including any on-site cutting or welding; and/or, failure to follow any and all maintenance instructions provided by Ameristar® at the time of sale to the original purchaser even if these instructions are not forwarded to the ultimate claimant under this warranty.
- When cutting Montage Plus immediately seal the exposed surfaces by 1) Removing all metal shavings from the cut area 2) Applying zinc-rich primer to thoroughly cover cut edge and drilled hole and, after letting dry, 3) Applying two (2) coats of custom finish spray paint matching fence color. Failure to seal exposed surfaces per steps 1-3 above will negate warranty.
- If contractor uses non-Ameristar parts/components, this will negate the warranty.

Ameristar Montage Plus welded ornamental fences are also guaranteed for the same period of time against defects in workmanship or materials. Should any Montage Plus welded ornamental panel or post manufactured by Ameristar fail in accordance with any of the above conditions, Ameristar warrants to the original purchaser their redemption through replacement, renewal or issuance of a pro-rated credit. The choice of redemption method is solely at the discretion of Ameristar. If the pro-rated alternative is chosen, the amount will be based on the original cost of materials at the date of purchase multiplied by the appropriate time and exposure factor from the table below:

APPLICATION	LENGTH OF WARRANTY
Fence Installations 0 to 1 Mile from Salt Water Coast Line	5 YEARS
Fence Installations 1 Mile to 10 Miles from Salt Water Coast Line	10 YEARS
Fence Installations Over 10 Miles from Salt Water Coast Line	20 YEARS

Regardless of location and years in service, evidence of historical salt spray exposure shall be considered as grounds to void any warranty obligations.

Notice of failure under the conditions of this warranty shall be sent to Ameristar or its authorized representative, in writing, together with proof of purchase and shall specify the nature of the defect and when it was first observed as well as photographs of current site conditions. Should the fence be improperly installed, Ameristar shall not be responsible for guaranteed performance or appearance of the material. Neither does this guarantee apply when failure or damage is due to improper use or application, abuse or misuse, salt spray exposure (see Table and Note above), vandalism, or acts of God. Ameristar reserves the right to inspect the material to determine validity of the claim.

Upon acceptance of the claim by Ameristar or its authorized representative, redemption by replacement, renewal or issuance of a pro-rated credit shall be made by Ameristar. Reimbursement for labor necessary to restore and/or replace components that have been found defective under the terms of this warranty is guaranteed to the original purchaser for a period of five (5) years from the original purchase date. Ameristar reserves the right to select the qualified company or individual to perform the labor to repair or replace the components that are deemed to be defective under the terms of this warranty.

The above constitutes the complete warranty by the manufacturer. No other agreement, written or implied, is valid. Ameristar Fence Products does not authorize any other person or agent to make any other express warranties. Ameristar neither assumes nor authorizes any other person or agent to assume any other liability in connection with the Montage Plus welded ornamental fence system.

Effective 08-14-12

MONTAGE PLUS® | SINGLE SWING GATE SPECIFICATIONS

1.75"sq x 14ga STEEL GATE ENDS | 1.4375" x 1.5" x 14ga RAILS | .75"sq x 18ga PICKETS | 3.5' - 16' NOMINAL OPENINGS

SINGLE SWING
DIMENSIONAL DRAWING

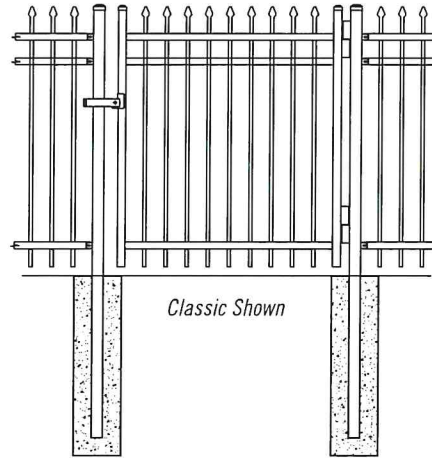

HGBS-25
HGBS-3 / HGBS-4
HEAVY COMMERCIAL
HINGE KITS

IGBS-25
IGBS-3 / IGBS-4
INDUSTRIAL HINGE
KITS

SINGLE SWING
HARDWARE KITS & POST
INTERSPACES

OPENING	LEAF WIDTH*	HC	LC	P _S	HC	LC	P _S
3.5'	40"	1.25"	3"	44.25"	1.5"	3"	44.5"
4'	49.5"	1.25"	3"	53.75"	1.5"	3"	54"
5'	58.75"	1.25"	3"	63"	1.5"	3"	63.25"
6'	68"	1.25"	3"	72.25"	1.5"	3"	72.5"
7'	86.75"	1.25"	3"	91"	1.5"	3"	91.25"
8'	95.5"	1.25"	3"	99.75"	1.5"	3"	100"
9'	105.5"	1.25"	3"	109.75"	1.5"	3"	110"
10'	114.75"	1.25"	3"	119"	1.5"	3"	119.25"
11'	133.5"	1.25"	3"	137.75"	1.5"	3"	138"
12'	143"	1.25"	3"	147.25"	1.5"	3"	147.5"
13'	152.25"	1.25"	3"	156.5"	1.5"	3"	156.75"
14'	171"	1.25"	3"	175.25"	1.5"	3"	175.5"
15'	180.25"	1.25"	3"	184.5"	1.5"	3"	184.75"
16'	189.75"	1.25"	3"	194"	1.5"	3"	194.25"

W = width* | HC = hinge clearance | LC = latch clearance | P_S = gate post spacing**
 * From outside to outside | ** From inside to inside

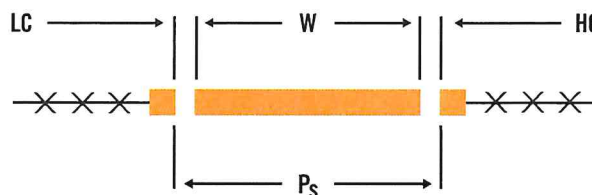

ENCLAVE DE 13-11

MONTAGE PLUS® | DOUBLE SWING GATE SPECIFICATIONS

1.75"sq x 14ga STEEL GATE ENDS | 1.4375" x 1.5" x 14ga RAILS | .75"sq x 18ga PICKETS | 7' - 32' NOMINAL OPENINGS

DOUBLE SWING
DIMENSIONAL DRAWING

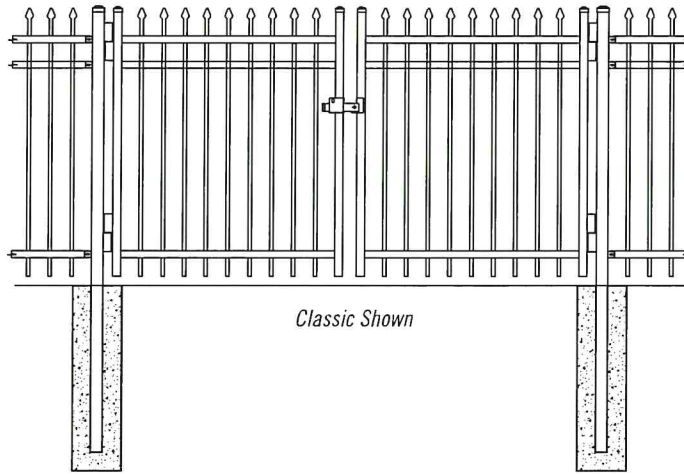

Classic Shown

IGBD
INDUSTRIAL HINGE
KITS

OPENING	LEAF WIDTH*	HC	LC	P _d
7'	40"	1.25"	3"	85.5"
8'	49.5"	1.25"	3"	104.5"
10'	58.75"	1.25"	3"	123"
12'	68"	1.25"	3"	141.5"
14'	86.75"	1.25"	3"	179"
16'	95.5"	1.25"	3"	196.5"
18'	105.5"	1.25"	3"	216.5"
20'	114.75"	1.25"	3"	235"
22'	133.5"	1.25"	3"	272.5"
24'	143"	1.25"	3"	291.5"
26'	152.25"	1.25"	3"	310"
28'	171"	1.25"	3"	347.5"
30'	180.25"	1.25"	3"	366"
32'	189.75"	1.25"	3"	385"

DOUBLE SWING
HARDWARE KITS & POST
INTERSPACES

W = width (x2)* | HC = hinge clearance (x2) | LC = latch clearance

P_d = gate post spacing**

* From outside to outside | ** From inside to inside

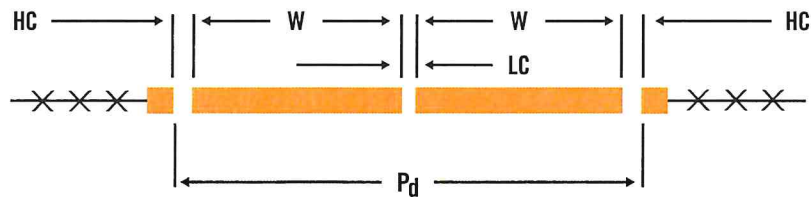

© 2014 Ameristar

MONTAGE PLUS® | 2-RAIL SINGLE SWING GATES

4" AIR GAP | STANDARD BOTTOM | GATE HARDWARE SOLD SEPARATELY

OPENING	LEAF WIDTH	ITEM NUMBER	PICKET QTY	WEIGHT	STOCKING	
3' HEIGHT	3.5'	40"	1W☒Ⓞ234-42	7	27 lbs	⊙
	4'	49.5"	1W☒Ⓞ234-48	9	32 lbs	⊙
	5'	58.75"	1W☒Ⓞ234-60	11	36 lbs	⊙
	6'	68"	1W☒Ⓞ234-72	13	41 lbs	⊙
	7'	86.75"	1W☒Ⓞ234-84	17	49 lbs	⊙
	8'	95.5"	1W☒Ⓞ234-96	19	53 lbs	⊙
	9'	105.5"	1W☒Ⓞ234-108	21	93 lbs	⊙
	10'	114.75"	1W☒Ⓞ234-120	23	102 lbs	⊙
	11'	133.5"	1W☒Ⓞ234-132	27	115 lbs	⊙
	12'	143"	1W☒Ⓞ234-144	29	129 lbs	⊙
	13'	152.25"	1W☒Ⓞ234-156	31	140 lbs	⊙
	14'	171"	1W☒Ⓞ234-168	35	148 lbs	⊙
15'	180.25"	1W☒Ⓞ234-180	37	156 lbs	⊙	
16'	189.75"	1W☒Ⓞ234-192	39	167 lbs	⊙	
3.5' HEIGHT	3.5'	40"	1W☒Ⓞ240-42	7	30 lbs	⊙
	4'	49.5"	1W☒Ⓞ240-48	9	36 lbs	⊙
	5'	58.75"	1W☒Ⓞ240-60	11	41 lbs	⊙
	6'	68"	1W☒Ⓞ240-72	13	46 lbs	⊙
	7'	86.75"	1W☒Ⓞ240-84	17	54 lbs	⊙
	8'	95.5"	1W☒Ⓞ240-96	19	73 lbs	⊙
	9'	105.5"	1W☒Ⓞ240-108	21	104 lbs	⊙
	10'	114.75"	1W☒Ⓞ240-120	23	113 lbs	⊙
	11'	133.5"	1W☒Ⓞ240-132	27	127 lbs	⊙
	12'	143"	1W☒Ⓞ240-144	29	142 lbs	⊙
	13'	152.25"	1W☒Ⓞ240-156	31	153 lbs	⊙
	14'	171"	1W☒Ⓞ240-168	35	162 lbs	⊙
15'	180.25"	1W☒Ⓞ240-180	37	171 lbs	⊙	
16'	189.75"	1W☒Ⓞ240-192	39	182 lbs	⊙	
4' HEIGHT	3.5'	40"	1W☒Ⓞ246-42	7	37 lbs	⊙
	4'	49.5"	1W☒Ⓞ246-48	9	40 lbs	⊙
	5'	58.75"	1W☒Ⓞ246-60	11	49 lbs	⊙
	6'	68"	1W☒Ⓞ246-72	13	57 lbs	⊙
	7'	86.75"	1W☒Ⓞ246-84	17	63 lbs	⊙
	8'	95.5"	1W☒Ⓞ246-96	19	73 lbs	⊙
	9'	105.5"	1W☒Ⓞ246-108	21	110 lbs	⊙
	10'	114.75"	1W☒Ⓞ246-120	23	121 lbs	⊙

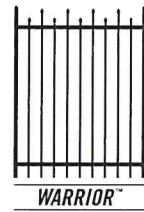
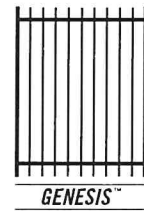
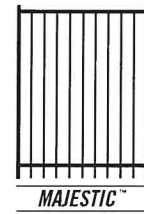
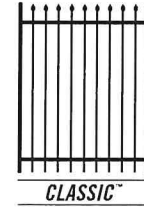

ADDITIONAL 4', 5' & 6' HEIGHTS CONTINUED ON NEXT PAGE

©2015 Amstar

MONTAGE PLUS[®] | 2-RAIL SINGLE SWING GATES

4" AIR GAP | STANDARD BOTTOM | GATE HARDWARE SOLD SEPARATELY

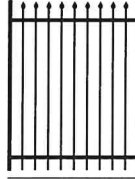
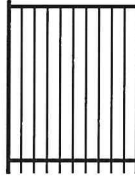
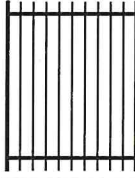
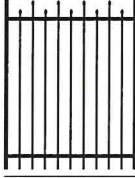
	OPENING	LEAF WIDTH	ITEM NUMBER	PICKET QTY	WEIGHT	STOCKING		
4' HEIGHT	11'	133.5"	1W☒Ⓞ246-132	27	138 lbs	☉	 CLASSIC™	
	12'	143"	1W☒Ⓞ246-144	29	155 lbs	☉		
	13'	152.25"	1W☒Ⓞ246-156	31	166 lbs	☉		
	14'	171"	1W☒Ⓞ246-168	35	176 lbs	☉		
	15'	180.25"	1W☒Ⓞ246-180	37	186 lbs	☉		
	16'	189.75"	1W☒Ⓞ246-192	39	197 lbs	☉		
5' HEIGHT	3.5'	40"	1W☒Ⓞ258-42	7	46 lbs	☉	 MAJESTIC™	
	4'	49.5"	1W☒Ⓞ258-48	9	49 lbs	☉		
	5'	58.75"	1W☒Ⓞ258-60	11	59 lbs	☉		
	6'	68"	1W☒Ⓞ258-72	13	69 lbs	☉		
	7'	86.75"	1W☒Ⓞ258-84	17	75 lbs	☉		
	8'	95.5"	1W☒Ⓞ258-96	19	88 lbs	☉		
	9'	105.5"	1W☒Ⓞ258-108	21	127 lbs	☉		
	10'	114.75"	1W☒Ⓞ258-120	23	140 lbs	☉		
	11'	133.5"	1W☒Ⓞ258-132	27	161 lbs	☉		
	12'	143"	1W☒Ⓞ258-144	29	181 lbs	☉		
6' HEIGHT	13'	152.25"	1W☒Ⓞ258-156	31	192 lbs	☉	 GENESIS™	
	14'	171"	1W☒Ⓞ258-168	35	204 lbs	☉		
	15'	180.25"	1W☒Ⓞ258-180	37	216 lbs	☉		
	16'	189.75"	1W☒Ⓞ258-192	39	227 lbs	☉		
	3.5'	40"	1W☒Ⓞ270-42	7	54 lbs	☉		 WARRIOR™
	4'	49.5"	1W☒Ⓞ270-48	9	58 lbs	☉		
	5'	58.75"	1W☒Ⓞ270-60	11	69 lbs	☉		
	6'	68"	1W☒Ⓞ270-72	13	80 lbs	☉		
	7'	86.75"	1W☒Ⓞ270-84	17	88 lbs	☉		
	8'	95.5"	1W☒Ⓞ270-96	19	104 lbs	☉		
9'	105.5"	1W☒Ⓞ270-108	21	144 lbs	☉			
10'	114.75"	1W☒Ⓞ270-120	23	159 lbs	☉			
11'	133.5"	1W☒Ⓞ270-132	27	183 lbs	☉			
12'	143"	1W☒Ⓞ270-144	29	206 lbs	☉			
13'	152.25"	1W☒Ⓞ270-156	31	220 lbs	☉			
14'	171"	1W☒Ⓞ270-168	35	233 lbs	☉			
15'	180.25"	1W☒Ⓞ270-180	37	246 lbs	☉			
16'	189.75"	1W☒Ⓞ270-192	39	258 lbs	☉			

☒ = FENCE STYLES AVAILABLE | C = Classic M = Majestic G = Genesis W = Warrior

Ⓞ = COLOR OPTIONS AVAILABLE | B = Black

☉ = NON-STOCKED PRODUCT

For details, see Ameristar's Sales Policy in the catalog guide.

MONTAGE PLUS® | 2-RAIL SINGLE SWING GATES

3" AIR GAP | STANDARD BOTTOM | GATE HARDWARE SOLD SEPARATELY

	OPENING	LEAF WIDTH	ITEM NUMBER	PICKET QTY	WEIGHT	STOCKING
3' HEIGHT	3.5'	40"	1R☒☉234-42	9	30 lbs	☉
	4'	49.5"	1R☒☉234-48	12	34 lbs	☉
	5'	58.75"	1R☒☉234-60	14	40 lbs	☉
	6'	68"	1R☒☉234-72	17	46 lbs	☉
	7'	86.75"	1R☒☉234-84	22	54 lbs	☉
	8'	95.5"	1R☒☉234-96	24	60 lbs	☉
3.5' HEIGHT	3.5'	40"	1R☒☉240-42	9	34 lbs	☉
	4'	49.5"	1R☒☉240-48	12	39 lbs	☉
	5'	58.75"	1R☒☉240-60	14	46 lbs	☉
	6'	68"	1R☒☉240-72	17	52 lbs	☉
	7'	86.75"	1R☒☉240-84	22	61 lbs	☉
	8'	95.5"	1R☒☉240-96	24	68 lbs	☉
4' HEIGHT	3.5'	40"	1R☒☉246-42	9	39 lbs	☉
	4'	49.5"	1R☒☉246-48	12	42 lbs	☉
	5'	58.75"	1R☒☉246-60	14	53 lbs	☉
	6'	68"	1R☒☉246-72	17	61 lbs	☉
	7'	86.75"	1R☒☉246-84	22	69 lbs	☉
	8'	95.5"	1R☒☉246-96	24	80 lbs	☉

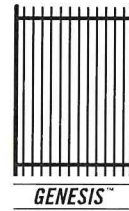
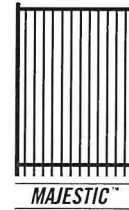
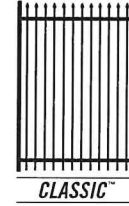

☒ = FENCE STYLES AVAILABLE | **C** = Classic **M** = Majestic **G** = Genesis

☉ = COLOR OPTIONS AVAILABLE | **B** = Black

☉ = NON-STOCKED PRODUCT

For details, see Ameristar's Sales Policy in the catalog guide.

Notes: Genesis panels are packaged with BLACK picket plugs.

Effective 06-18-22

MONTAGE PLUS[®] | 2-RAIL SINGLE SWING GATES

3" AIR GAP | STANDARD BOTTOM | GATE HARDWARE SOLD SEPARATELY

	OPENING	LEAF WIDTH	ITEM NUMBER	PICKET QTY	WEIGHT	STOCKING
5' HEIGHT	3.5'	40"	1R☒☉258-42	9	48 lbs	☉
	4'	49.5"	1R☒☉258-48	12	51 lbs	☉
	5'	58.75"	1R☒☉258-60	14	64 lbs	☉
	6'	68"	1R☒☉258-72	17	74 lbs	☉
	7'	86.75"	1R☒☉258-84	22	83 lbs	☉
	8'	95.5"	1R☒☉258-96	24	97 lbs	☉
6' HEIGHT	3.5'	40"	1R☒☉270-42	9	56 lbs	☉
	4'	49.5"	1R☒☉270-48	12	60 lbs	☉
	5'	58.75"	1R☒☉270-60	14	75 lbs	☉
	6'	68"	1R☒☉270-72	17	87 lbs	☉
	7'	86.75"	1R☒☉270-84	22	97 lbs	☉
	8'	95.5"	1R☒☉270-96	24	113 lbs	☉

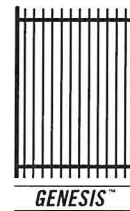
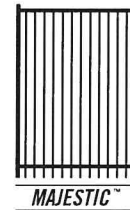
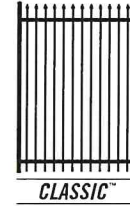

☒ = FENCE STYLES AVAILABLE | C = Classic | M = Majestic | G = Genesis

☉ = COLOR OPTIONS AVAILABLE | B = Black

☉ = NON-STOCKED PRODUCT

For details, see Ameristar's Sales Policy in the catalog guide.

Notes: Genesis panels are packaged with BLACK picket plugs.

Effective 10-15-21

MONTAGE PLUS® | 2-RAIL SINGLE SWING GATES

4" AIR GAP | FLUSH BOTTOM | GATE HARDWARE SOLD SEPARATELY

OPENING	LEAF WIDTH	ITEM NUMBER	PICKET QTY	WEIGHT	STOCKING
3.5'	40"	1W☒Ⓞ234F-42	7	27 lbs	☉
4'	49.5"	1W☒Ⓞ234F-48	9	32 lbs	☉
5'	58.75"	1W☒Ⓞ234F-60	11	36 lbs	☉
6'	68"	1W☒Ⓞ234F-72	13	41 lbs	☉
7'	86.75"	1W☒Ⓞ234F-84	17	49 lbs	☉
8'	95.5"	1W☒Ⓞ234F-96	19	53 lbs	☉
9'	105.5"	1W☒Ⓞ234F-108	21	93 lbs	☉
10'	114.75"	1W☒Ⓞ234F-120	23	102 lbs	☉
11'	133.5"	1W☒Ⓞ234F-132	27	115 lbs	☉
12'	143"	1W☒Ⓞ234F-144	29	129 lbs	☉
13'	152.25"	1W☒Ⓞ234F-156	31	140 lbs	☉
14'	171"	1W☒Ⓞ234F-168	35	148 lbs	☉
15'	180.25"	1W☒Ⓞ234F-180	37	156 lbs	☉
16'	189.75"	1W☒Ⓞ234F-192	39	167 lbs	☉
3.5'	40"	1W☒Ⓞ240F-42	7	30 lbs	☉
4'	49.5"	1W☒Ⓞ240F-48	9	36 lbs	☉
5'	58.75"	1W☒Ⓞ240F-60	11	41 lbs	☉
6'	68"	1W☒Ⓞ240F-72	13	46 lbs	☉
7'	86.75"	1W☒Ⓞ240F-84	17	54 lbs	☉
8'	95.5"	1W☒Ⓞ240F-96	19	73 lbs	☉
9'	105.5"	1W☒Ⓞ240F-108	21	104 lbs	☉
10'	114.75"	1W☒Ⓞ240F-120	23	113 lbs	☉
11'	133.5"	1W☒Ⓞ240F-132	27	127 lbs	☉
12'	143"	1W☒Ⓞ240F-144	29	142 lbs	☉
13'	152.25"	1W☒Ⓞ240F-156	31	153 lbs	☉
14'	171"	1W☒Ⓞ240F-168	35	162 lbs	☉
15'	180.25"	1W☒Ⓞ240F-180	37	171 lbs	☉
16'	189.75"	1W☒Ⓞ240F-192	39	182 lbs	☉
3.5'	40"	1W☒Ⓞ246F-42	7	37 lbs	☉
4'	49.5"	1W☒Ⓞ246F-48	9	40 lbs	☉
5'	58.75"	1W☒Ⓞ246F-60	11	49 lbs	☉
6'	68"	1W☒Ⓞ246F-72	13	57 lbs	☉
7'	86.75"	1W☒Ⓞ246F-84	17	63 lbs	☉
8'	95.5"	1W☒Ⓞ246F-96	19	73 lbs	☉
9'	105.5"	1W☒Ⓞ246F-108	21	110 lbs	☉
10'	114.75"	1W☒Ⓞ246F-120	23	121 lbs	☉

3'
HEIGHT

3.5'
HEIGHT

4'
HEIGHT



CLASSIC™

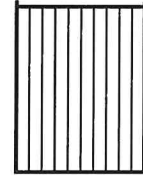

MAJESTIC™

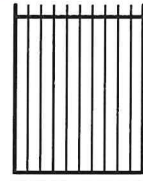

GENESIS™

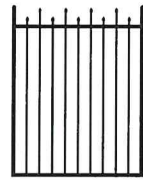



WARRIOR™

ADDITIONAL 4', 5' & 6' HEIGHTS CONTINUED ON NEXT PAGE

©2015 Ameristar

MONTAGE PLUS® | 2-RAIL SINGLE SWING GATES

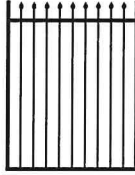
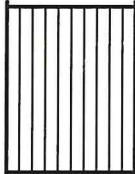
4" AIR GAP | FLUSH BOTTOM | GATE HARDWARE SOLD SEPARATELY

	OPENING	LEAF WIDTH	ITEM NUMBER	PICKET QTY	WEIGHT	STOCKING		
4' HEIGHT	11'	133.5"	1W☒Ⓞ246F-132	27	138 lbs	☉	 CLASSIC™	
	12'	143"	1W☒Ⓞ246F-144	29	155 lbs	☉		
	13'	152.25"	1W☒Ⓞ246F-156	31	166 lbs	☉		
	14'	171"	1W☒Ⓞ246F-168	35	176 lbs	☉		
	15'	180.25"	1W☒Ⓞ246F-180	37	186 lbs	☉		
	16'	189.75"	1W☒Ⓞ246F-192	39	197 lbs	☉		
5' HEIGHT	3.5'	40"	1W☒Ⓞ258F-42	7	46 lbs	☉	 MAJESTIC™	
	4'	49.5"	1W☒Ⓞ258F-48	9	49 lbs	☉		
	5'	58.75"	1W☒Ⓞ258F-60	11	59 lbs	☉		
	6'	68"	1W☒Ⓞ258F-72	13	69 lbs	☉		
	7'	86.75"	1W☒Ⓞ258F-84	17	75 lbs	☉		
	8'	95.5"	1W☒Ⓞ258F-96	19	88 lbs	☉		
	9'	105.5"	1W☒Ⓞ258F-108	21	127 lbs	☉		
	10'	114.75"	1W☒Ⓞ258F-120	23	140 lbs	☉		
	11'	133.5"	1W☒Ⓞ258F-132	27	161 lbs	☉		
	12'	143"	1W☒Ⓞ258F-144	29	181 lbs	☉		
6' HEIGHT	13'	152.25"	1W☒Ⓞ258F-156	31	192 lbs	☉	 GENESIS™	
	14'	171"	1W☒Ⓞ258F-168	35	204 lbs	☉		
	15'	180.25"	1W☒Ⓞ258F-180	37	216 lbs	☉		
	16'	189.75"	1W☒Ⓞ258F-192	39	227 lbs	☉		
	3.5'	40"	1W☒Ⓞ270F-42	7	54 lbs	☉		 WARRIOR™
	4'	49.5"	1W☒Ⓞ270F-48	9	58 lbs	☉		
	5'	58.75"	1W☒Ⓞ270F-60	11	69 lbs	☉		
	6'	68"	1W☒Ⓞ270F-72	13	80 lbs	☉		
	7'	86.75"	1W☒Ⓞ270F-84	17	88 lbs	☉		
	8'	95.5"	1W☒Ⓞ270F-96	19	104 lbs	☉		
9'	105.5"	1W☒Ⓞ270F-108	21	144 lbs	☉			
10'	114.75"	1W☒Ⓞ270F-120	23	159 lbs	☉			
11'	133.5"	1W☒Ⓞ270F-132	27	183 lbs	☉			
12'	143"	1W☒Ⓞ270F-144	29	206 lbs	☉			
13'	152.25"	1W☒Ⓞ270F-156	31	220 lbs	☉			
14'	171"	1W☒Ⓞ270F-168	35	233 lbs	☉			
15'	180.25"	1W☒Ⓞ270F-180	37	246 lbs	☉			
16'	189.75"	1W☒Ⓞ270F-192	39	258 lbs	☉			

☒ = FENCE STYLES AVAILABLE | C = Classic M = Majestic G = Genesis W = Warrior

Ⓞ = COLOR OPTIONS AVAILABLE | B = Black

☉ = NON-STOCKED PRODUCT

For details, see Ameristar's Sales Policy in the catalog guide.

Effective 10-14-22

MONTAGE PLUS® | 2-RAIL SINGLE SWING GATES

3" AIR GAP | FLUSH BOTTOM | GATE HARDWARE SOLD SEPARATELY

	OPENING	LEAF WIDTH	ITEM NUMBER	PICKET QTY	WEIGHT	STOCKING
3' HEIGHT	3.5'	40"	1R☒ⓧ234F-42	9	30 lbs	⊙
	4'	49.5"	1R☒ⓧ234F-48	12	34 lbs	⊙
	5'	58.75"	1R☒ⓧ234F-60	14	40 lbs	⊙
	6'	68"	1R☒ⓧ234F-72	17	46 lbs	⊙
	7'	86.75"	1R☒ⓧ234F-84	22	54 lbs	⊙
	8'	95.5"	1R☒ⓧ234F-96	24	60 lbs	⊙
3.5' HEIGHT	3.5'	40"	1R☒ⓧ240F-42	9	34 lbs	⊙
	4'	49.5"	1R☒ⓧ240F-48	12	39 lbs	⊙
	5'	58.75"	1R☒ⓧ240F-60	14	46 lbs	⊙
	6'	68"	1R☒ⓧ240F-72	17	52 lbs	⊙
	7'	86.75"	1R☒ⓧ240F-84	22	61 lbs	⊙
	8'	95.5"	1R☒ⓧ240F-96	24	68 lbs	⊙
4' HEIGHT	3.5'	40"	1R☒ⓧ246F-42	9	39 lbs	⊙
	4'	49.5"	1R☒ⓧ246F-48	12	42 lbs	⊙
	5'	58.75"	1R☒ⓧ246F-60	14	53 lbs	⊙
	6'	68"	1R☒ⓧ246F-72	17	61 lbs	⊙
	7'	86.75"	1R☒ⓧ246F-84	22	69 lbs	⊙
	8'	95.5"	1R☒ⓧ246F-96	24	80 lbs	⊙

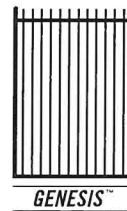
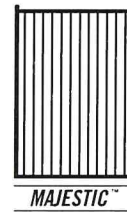
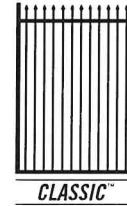

☒ = FENCE STYLES AVAILABLE | C = Classic M = Majestic G = Genesis

ⓧ = COLOR OPTIONS AVAILABLE | B = Black

⊙ = NON-STOCKED PRODUCT

For details, see Ameristar's Sales Policy in the catalog guide.

Notes: Genesis panels are packaged with BLACK picket plugs.

Effective 08/15/22

MONTAGE PLUS[®] | 2-RAIL SINGLE SWING GATES

3" AIR GAP | FLUSH BOTTOM | GATE HARDWARE SOLD SEPARATELY

	OPENING	LEAF WIDTH	ITEM NUMBER	PICKET QTY	WEIGHT	STOCKING
5' HEIGHT	3.5'	40"	1R☒⊗258F-42	9	48 lbs	⊙
	4'	49.5"	1R☒⊗258F-48	12	51 lbs	⊙
	5'	58.75"	1R☒⊗258F-60	14	64 lbs	⊙
	6'	68"	1R☒⊗258F-72	17	74 lbs	⊙
	7'	86.75"	1R☒⊗258F-84	22	83 lbs	⊙
6' HEIGHT	8'	95.5"	1R☒⊗258F-96	24	97 lbs	⊙
	3.5'	40"	1R☒⊗270F-42	9	56 lbs	⊙
	4'	49.5"	1R☒⊗270F-48	12	60 lbs	⊙
	5'	58.75"	1R☒⊗270F-60	14	75 lbs	⊙
	6'	68"	1R☒⊗270F-72	17	87 lbs	⊙
	7'	86.75"	1R☒⊗270F-84	22	97 lbs	⊙
	8'	95.5"	1R☒⊗270F-96	24	113 lbs	⊙

☒ = FENCE STYLES AVAILABLE | C = Classic M = Majestic G = Genesis

⊗ = COLOR OPTIONS AVAILABLE | B = Black

⊙ = NON-STOCKED PRODUCT

For details, see Ameristar's Sales Policy in the catalog guide.

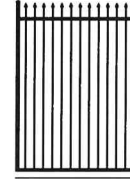

CLASSIC™

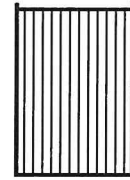

MAJESTIC™

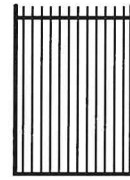

GENESIS™

Notes: Genesis panels are packaged with BLACK picket plugs.

Illustration 36-11-21

MONTAGE PLUS® | 3-RAIL SINGLE SWING GATES

4" AIR GAP | STANDARD BOTTOM | GATE HARDWARE SOLD SEPARATELY

OPENING	LEAF WIDTH	ITEM NUMBER	PICKET QTY	WEIGHT	STOCKING	
3' HEIGHT	3.5'	40"	1W☒Ⓞ334-42	7	30 lbs	⊙
	4'	49.5"	1W☒Ⓞ334-48	9	36 lbs	⊙
	5'	58.75"	1W☒Ⓞ334-60	11	41 lbs	⊙
	6'	68"	1W☒Ⓞ334-72	13	47 lbs	⊙
	7'	86.75"	1W☒Ⓞ334-84	17	57 lbs	⊙
	8'	95.5"	1W☒Ⓞ334-96	19	62 lbs	⊙
	9'	105.5"	1W☒Ⓞ334-108	21	100 lbs	⊙
	10'	114.75"	1W☒Ⓞ334-120	23	123 lbs	⊙
	11'	133.5"	1W☒Ⓞ334-132	27	138 lbs	⊙
	12'	143"	1W☒Ⓞ334-144	29	153 lbs	⊙
	13'	152.25"	1W☒Ⓞ334-156	31	164 lbs	⊙
	14'	171"	1W☒Ⓞ334-168	35	176 lbs	⊙
3.5' HEIGHT	15'	180.25"	1W☒Ⓞ334-180	37	189 lbs	⊙
	16'	189.75"	1W☒Ⓞ334-192	39	202 lbs	⊙
	3.5'	40"	1W☒Ⓞ340-42	7	34 lbs	⊙
	4'	49.5"	1W☒Ⓞ340-48	9	40 lbs	⊙
	5'	58.75"	1W☒Ⓞ340-60	11	46 lbs	⊙
	6'	68"	1W☒Ⓞ340-72	13	47 lbs	⊙
	7'	86.75"	1W☒Ⓞ340-84	17	62 lbs	⊙
	8'	95.5"	1W☒Ⓞ340-96	19	68 lbs	⊙
	9'	105.5"	1W☒Ⓞ340-108	21	115 lbs	⊙
	10'	114.75"	1W☒Ⓞ340-120	23	133 lbs	⊙
	11'	133.5"	1W☒Ⓞ340-132	27	150 lbs	⊙
	12'	143"	1W☒Ⓞ340-144	29	167 lbs	⊙
4' HEIGHT	13'	152.25"	1W☒Ⓞ340-156	31	179 lbs	⊙
	14'	171"	1W☒Ⓞ340-168	35	191 lbs	⊙
	15'	180.25"	1W☒Ⓞ340-180	37	204 lbs	⊙
	16'	189.75"	1W☒Ⓞ340-192	39	217 lbs	⊙
	3.5'	40"	1W☒Ⓞ346-42	7	41 lbs	⊙
	4'	49.5"	1W☒Ⓞ346-48	9	44 lbs	MB
	5'	58.75"	1W☒Ⓞ346-60	11	54 lbs	⊙
	6'	68"	1W☒Ⓞ346-72	13	63 lbs	⊙
	7'	86.75"	1W☒Ⓞ346-84	17	70 lbs	⊙
	8'	95.5"	1W☒Ⓞ346-96	19	82 lbs	⊙
	9'	105.5"	1W☒Ⓞ346-108	21	130 lbs	⊙
	10'	114.75"	1W☒Ⓞ346-120	23	143 lbs	⊙

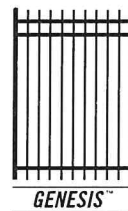
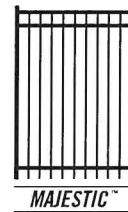
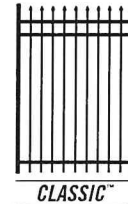

ADDITIONAL 4', 5' & 6' HEIGHTS CONTINUED ON NEXT PAGE

MONTAGE PLUS® | 3-RAIL SINGLE SWING GATES

4" AIR GAP | STANDARD BOTTOM | GATE HARDWARE SOLD SEPARATELY

	OPENING	LEAF WIDTH	ITEM NUMBER	PICKET QTY	WEIGHT	STOCKING
4' HEIGHT	11'	133.5"	1W☒☒346-132	27	162 lbs	☉
	12'	143"	1W☒☒346-144	29	181 lbs	☉
	13'	152.25"	1W☒☒346-156	31	194 lbs	☉
	14'	171"	1W☒☒346-168	35	206 lbs	☉
	15'	180.25"	1W☒☒346-180	37	219 lbs	☉
	16'	189.75"	1W☒☒346-192	39	232 lbs	☉
5' HEIGHT	3.5'	40"	1W☒☒358-42	7	49 lbs	☉
	4'	49.5"	1W☒☒358-48	9	53 lbs	☉
	5'	58.75"	1W☒☒358-60	11	64 lbs	☉
	6'	68"	1W☒☒358-72	13	74 lbs	☉
	7'	86.75"	1W☒☒358-84	17	82 lbs	☉
	8'	95.5"	1W☒☒358-96	19	97 lbs	☉
	9'	105.5"	1W☒☒358-108	21	159 lbs	☉
	10'	114.75"	1W☒☒358-120	23	162 lbs	☉
	11'	133.5"	1W☒☒358-132	27	185 lbs	☉
	12'	143"	1W☒☒358-144	29	208 lbs	☉
6' HEIGHT	13'	152.25"	1W☒☒358-156	31	222 lbs	☉
	14'	171"	1W☒☒358-168	35	235 lbs	☉
	15'	180.25"	1W☒☒358-180	37	249 lbs	☉
	16'	189.75"	1W☒☒358-192	39	262 lbs	☉
	3.5'	40"	1W☒☒370-42	7	57 lbs	☉
	4'	49.5"	1W☒☒370-48	9	62 lbs	MB GB
	5'	58.75"	1W☒☒370-60	11	74 lbs	MB
	6'	68"	1W☒☒370-72	13	87 lbs	☉
	7'	86.75"	1W☒☒370-84	17	95 lbs	☉
	8'	95.5"	1W☒☒370-96	19	112 lbs	☉
9'	105.5"	1W☒☒370-108	21	161 lbs	☉	
10'	114.75"	1W☒☒370-120	23	181 lbs	☉	
11'	133.5"	1W☒☒370-132	27	207 lbs	☉	
12'	143"	1W☒☒370-144	29	233 lbs	☉	
13'	152.25"	1W☒☒370-156	31	248 lbs	☉	
14'	171"	1W☒☒370-168	35	263 lbs	☉	
15'	180.25"	1W☒☒370-180	37	279 lbs	☉	
16'	189.75"	1W☒☒370-192	39	294 lbs	☉	

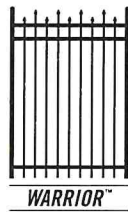
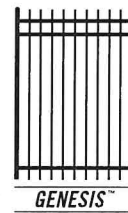
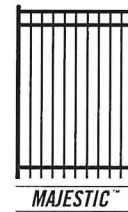
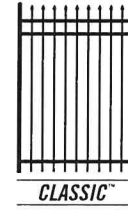

☒ = FENCE STYLES AVAILABLE | C = Classic M = Majestic G = Genesis W = Warrior

☒ = COLOR OPTIONS AVAILABLE | B = Black

☉ = NON-STOCKED PRODUCT

For details, see Ameristar's Sales Policy in the catalog guide.

© 2016 Ameristar

MONTAGE PLUS® | 3-RAIL SINGLE SWING GATES

3" AIR GAP | STANDARD BOTTOM | GATE HARDWARE SOLD SEPARATELY

	OPENING	LEAF WIDTH	ITEM NUMBER	PICKET QTY	WEIGHT	STOCKING
3' HEIGHT	3.5'	40"	1R☒Ⓞ334-42	9	33 lbs	⊙
	4'	49.5"	1R☒Ⓞ334-48	12	35 lbs	⊙
	5'	58.75"	1R☒Ⓞ334-60	14	46 lbs	⊙
	6'	68"	1R☒Ⓞ334-72	17	53 lbs	⊙
	7'	86.75"	1R☒Ⓞ334-84	22	62 lbs	⊙
	8'	95.5"	1R☒Ⓞ334-96	24	69 lbs	⊙
3.5' HEIGHT	3.5'	40"	1R☒Ⓞ340-42	9	37 lbs	⊙
	4'	49.5"	1R☒Ⓞ340-48	12	39 lbs	⊙
	5'	58.75"	1R☒Ⓞ340-60	14	51 lbs	⊙
	6'	68"	1R☒Ⓞ340-72	17	59 lbs	⊙
	7'	86.75"	1R☒Ⓞ340-84	22	69 lbs	⊙
	8'	95.5"	1R☒Ⓞ340-96	24	77 lbs	⊙
4' HEIGHT	3.5'	40"	1R☒Ⓞ346-42	9	43 lbs	⊙
	4'	49.5"	1R☒Ⓞ346-48	12	47 lbs	⊙
	5'	58.75"	1R☒Ⓞ346-60	14	58 lbs	⊙
	6'	68"	1R☒Ⓞ346-72	17	67 lbs	⊙
	7'	86.75"	1R☒Ⓞ346-84	22	76 lbs	⊙
	8'	95.5"	1R☒Ⓞ346-96	24	88 lbs	⊙

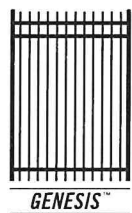
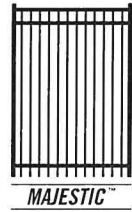
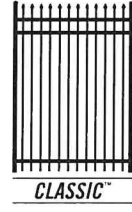

5' & 6' HEIGHTS CONTINUED ON NEXT PAGE

☒ = FENCE STYLES AVAILABLE | C = Classic M = Majestic G = Genesis
 Ⓞ = COLOR OPTIONS AVAILABLE | B = Black
 ⊙ = NON-STOCKED PRODUCT
 For details, see Ameristar's Sales Policy in the catalog guide.

Notes: Genesis panels are packaged with BLACK picket plugs.

MONTAGE PLUS® | 3-RAIL SINGLE SWING GATES

3" AIR GAP | STANDARD BOTTOM | GATE HARDWARE SOLD SEPARATELY

	OPENING	LEAF WIDTH	ITEM NUMBER	PICKET QTY	WEIGHT	STOCKING
5' HEIGHT	3.5'	40"	1R☒☉358-42	9	51 lbs	☉
	4'	49.5"	1R☒☉358-48	12	55 lbs	☉
	5'	58.75"	1R☒☉358-60	14	69 lbs	☉
	6'	68"	1R☒☉358-72	17	80 lbs	☉
	7'	86.75"	1R☒☉358-84	22	90 lbs	☉
	8'	95.5"	1R☒☉358-96	24	105 lbs	☉
6' HEIGHT	3.5'	40"	1R☒☉370-42	9	60 lbs	☉
	4'	49.5"	1R☒☉370-48	12	64 lbs	☉
	5'	58.75"	1R☒☉370-60	14	80 lbs	☉
	6'	68"	1R☒☉370-72	17	93 lbs	☉
	7'	86.75"	1R☒☉370-84	22	104 lbs	☉
	8'	95.5"	1R☒☉370-96	24	118 lbs	☉

☒ = FENCE STYLES AVAILABLE | C = Classic M = Majestic G = Genesis

☉ = COLOR OPTIONS AVAILABLE | B = Black

☉ = NON-STOCKED PRODUCT

For details, see Ameristar's Sales Policy in the catalog guide.

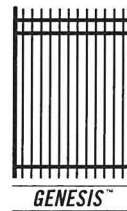
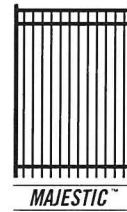
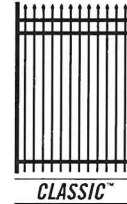

Notes: Genesis panels are packaged with BLACK picket plugs.

Product ID: 14-22

MONTAGE PLUS® | 3-RAIL SINGLE SWING GATES

4" AIR GAP | FLUSH BOTTOM | GATE HARDWARE SOLD SEPARATELY

OPENING	LEAF WIDTH	ITEM NUMBER	PICKET QTY	WEIGHT	STOCKING
3.5'	40"	1W☒ⓧ334F-42	7	60 lbs	⊙
4'	49.5"	1W☒ⓧ334F-48	9	36 lbs	⊙
5'	58.75"	1W☒ⓧ334F-60	11	41 lbs	⊙
6'	68"	1W☒ⓧ334F-72	13	47 lbs	⊙
7'	86.75"	1W☒ⓧ334F-84	17	57 lbs	⊙
8'	95.5"	1W☒ⓧ334F-96	19	62 lbs	⊙
9'	105.5"	1W☒ⓧ334F-108	21	100 lbs	⊙
10'	114.75"	1W☒ⓧ334F-120	23	123 lbs	⊙
11'	133.5"	1W☒ⓧ334F-132	27	138 lbs	⊙
12'	143"	1W☒ⓧ334F-144	29	153 lbs	⊙
13'	152.25"	1W☒ⓧ334F-156	31	164 lbs	⊙
14'	171"	1W☒ⓧ334F-168	35	176 lbs	⊙
15'	180.25"	1W☒ⓧ334F-180	37	189 lbs	⊙
16'	189.75"	1W☒ⓧ334F-192	39	202 lbs	⊙
<hr/>					
3.5'	40"	1W☒ⓧ340F-42	7	34 lbs	⊙
4'	49.5"	1W☒ⓧ340F-48	9	40 lbs	⊙
5'	58.75"	1W☒ⓧ340F-60	11	46 lbs	⊙
6'	68"	1W☒ⓧ340F-72	13	47 lbs	⊙
7'	86.75"	1W☒ⓧ340F-84	17	62 lbs	⊙
8'	95.5"	1W☒ⓧ340F-96	19	68 lbs	⊙
9'	105.5"	1W☒ⓧ340F-108	21	115 lbs	⊙
10'	114.75"	1W☒ⓧ340F-120	23	133 lbs	⊙
11'	133.5"	1W☒ⓧ340F-132	27	150 lbs	⊙
12'	143"	1W☒ⓧ340F-144	29	167 lbs	⊙
13'	152.25"	1W☒ⓧ340F-156	31	179 lbs	⊙
14'	171"	1W☒ⓧ340F-168	35	191 lbs	⊙
15'	180.25"	1W☒ⓧ340F-180	37	204 lbs	⊙
16'	189.75"	1W☒ⓧ340F-192	39	217 lbs	⊙

3'
HEIGHT

3.5'
HEIGHT



CLASSIC™

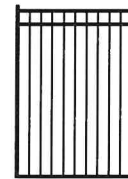

MAJESTIC™



GENESIS™

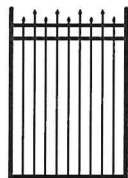

WARRIOR™

4', 4.5', 5' & 6' HEIGHTS CONTINUED ON NEXT PAGES

☒ = FENCE STYLES AVAILABLE | ☒ = Classic M = Majestic G = Genesis W = Warrior

ⓧ = COLOR OPTIONS AVAILABLE | B = Black

⊙ = NON-STOCKED PRODUCT



For details, see Ameristar's Sales Policy in the catalog guide.

Notes: Genesis panels are packaged with BLACK picket plugs.

2/16/21 ver. 1/28/18-22

MONTAGE PLUS® | 3-RAIL SINGLE SWING GATES

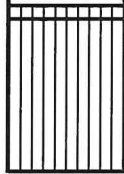
4" AIR GAP | FLUSH BOTTOM | GATE HARDWARE SOLD SEPARATELY

OPENING	LEAF WIDTH	ITEM NUMBER	PICKET QTY	WEIGHT	STOCKING				
4' HEIGHT	3.5'	40"	1W☒⊗346F-42	7	41 lbs	☉	 CLASSIC™		
	4'	49.5"	1W☒⊗346F-48	9	44 lbs	☉			
	5'	58.75"	1W☒⊗346F-60	11	54 lbs	☉			
	6'	68"	1W☒⊗346F-72	13	63 lbs	☉			
	7'	86.75"	1W☒⊗346F-84	17	70 lbs	☉			
	8'	95.5"	1W☒⊗346F-96	19	82 lbs	☉			
	9'	105.5"	1W☒⊗346F-108	21	130 lbs	☉	 MAJESTIC™		
	10'	114.75"	1W☒⊗346F-120	23	143 lbs	☉			
	11'	133.5"	1W☒⊗346F-132	27	162 lbs	☉			
	12'	143"	1W☒⊗346F-144	29	181 lbs	☉			
	13'	152.25"	1W☒⊗346F-156	31	194 lbs	☉			
	14'	171"	1W☒⊗346F-168	35	206 lbs	☉			
	15'	180.25"	1W☒⊗346F-180	37	219 lbs	☉	 GENESIS™		
	16'	189.75"	1W☒⊗346F-192	39	232 lbs	☉			
	4.5' HEIGHT	3.5'	40"	1WM⊗354F-42*	7	47 lbs		☉	 WARRIOR™
		4'	49.5"	1WM⊗354F-48*	9	51 lbs		☉	
5'		58.75"	1WM⊗354F-60*	11	62 lbs	☉			
6'		68"	1WM⊗354F-72*	13	72 lbs	☉			
7'		86.75"	1WM⊗354F-84*	17	80 lbs	☉			
8'		95.5"	1WM⊗354F-96*	19	95 lbs	☉			
9'		105.5"	1WM⊗354F-108*	21	147 lbs	☉			
10'		114.75"	1WM⊗354F-120*	23	155 lbs	☉			
11'		133.5"	1WM⊗354F-132*	27	176 lbs	☉			
12'		143"	1WM⊗354F-144*	29	197 lbs	☉			
13'		152.25"	1WM⊗354F-156*	31	210 lbs	☉			
14'		171"	1WM⊗354F-168*	35	223 lbs	☉			
15'		180.25"	1WM⊗354F-180*	37	236 lbs	☉			
16'		189.75"	1WM⊗354F-192*	39	249 lbs	☉			

5' & 6' HEIGHTS CONTINUED ON NEXT PAGES

☒ = FENCE STYLES AVAILABLE | C = Classic M = Majestic G = Genesis W = Warrior

⊗ = COLOR OPTIONS AVAILABLE | B = Black

☉ = NON-STOCKED PRODUCT

For details, see Ameristar's Sales Policy in the catalog guide.

* 4.5' flush bottom gates available in Majestic only

Notes: Genesis panels are packaged with BLACK picket plugs.

Photo 16-142

MONTAGE PLUS® | 3-RAIL SINGLE SWING GATES

4" AIR GAP | FLUSH BOTTOM | GATE HARDWARE SOLD SEPARATELY

5'
HEIGHT

OPENING	LEAF WIDTH	ITEM NUMBER	PICKET QTY	WEIGHT	STOCKING
3.5'	40"	1W☒⊗358F-42	7	49 lbs	☉
4'	49.5"	1W☒⊗358F-48	9	53 lbs	☉
5'	58.75"	1W☒⊗358F-60	11	64 lbs	☉
6'	68"	1W☒⊗358F-72	13	74 lbs	☉
7'	86.75"	1W☒⊗358F-84	17	82 lbs	☉
8'	95.5"	1W☒⊗358F-96	19	97 lbs	☉
9'	105.5"	1W☒⊗358F-108	21	159 lbs	☉
10'	114.75"	1W☒⊗358F-120	23	162 lbs	☉
11'	133.5"	1W☒⊗358F-132	27	185 lbs	☉
12'	143"	1W☒⊗358F-144	29	208 lbs	☉
13'	152.25"	1W☒⊗358F-156	31	222 lbs	☉
14'	171"	1W☒⊗358F-168	35	235 lbs	☉
15'	180.25"	1W☒⊗358F-180	37	249 lbs	☉
16'	189.75"	1W☒⊗358F-192	39	262 lbs	☉

6' HEIGHTS CONTINUED ON FOLLOWING PAGE

- ☒ = FENCE STYLES AVAILABLE | C = Classic M = Majestic G = Genesis W = Warrior
 - ⊗ = COLOR OPTIONS AVAILABLE | B = Black
 - ☉ = NON-STOCKED PRODUCT
- For details, see Ameristar's Sales Policy in the catalog guide.*

Notes: Genesis panels are packaged with BLACK picket plugs.

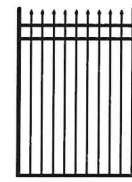

CLASSIC™



MAJESTIC™

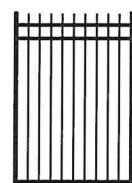

GENESIS™



WARRIOR™

effective 10/14/21

MONTAGE PLUS® | 3-RAIL SINGLE SWING GATES

4" AIR GAP | FLUSH BOTTOM | GATE HARDWARE SOLD SEPARATELY

OPENING	LEAF WIDTH	ITEM NUMBER	PICKET QTY	WEIGHT	STOCKING
3.5'	40"	1W☒☉370F-42	7	57 lbs	☉
4'	49.5"	1W☒☉370F-48	9	62 lbs	☉
5'	58.75"	1W☒☉370F-60	11	74 lbs	☉
6'	68"	1W☒☉370F-72	13	87 lbs	☉
7'	86.75"	1W☒☉370F-84	17	95 lbs	☉
8'	95.5"	1W☒☉370F-96	19	112 lbs	☉
9'	105.5"	1W☒☉370F-108	21	161 lbs	☉
10'	114.75"	1W☒☉370F-120	23	181 lbs	☉
11'	133.5"	1W☒☉370F-132	27	207 lbs	☉
12'	143"	1W☒☉370F-144	29	233 lbs	☉
13'	152.25"	1W☒☉370F-156	31	248 lbs	☉
14'	171"	1W☒☉370F-168	35	263 lbs	☉
15'	180.25"	1W☒☉370F-180	37	279 lbs	☉
16'	189.75"	1W☒☉370F-192	39	294 lbs	☉

6'
HEIGHT



CLASSIC™

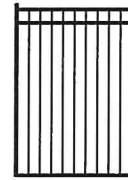

MAJESTIC™



GENESIS™

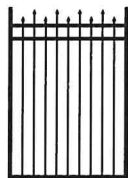

WARRIOR™

☒ = FENCE STYLES AVAILABLE | **C** = Classic **M** = Majestic **G** = Genesis **W** = Warrior

☉ = COLOR OPTIONS AVAILABLE | **B** = Black

☉ = NON-STOCKED PRODUCT

For details, see Ameristar's Sales Policy in the catalog guide.

Notes: Genesis panels are packaged with BLACK picket plugs.

Effective 10-13-21

MONTAGE PLUS® | 3-RAIL SINGLE SWING GATES

3" AIR GAP | FLUSH BOTTOM | GATE HARDWARE SOLD SEPARATELY

	OPENING	LEAF WIDTH	ITEM NUMBER	PICKET QTY	WEIGHT	STOCKING
3' HEIGHT	3.5'	40"	1R☒☒334F-42	9	33 lbs	☉
	4'	49.5"	1R☒☒334F-48	12	35 lbs	☉
	5'	58.75"	1R☒☒334F-60	14	46 lbs	☉
	6'	68"	1R☒☒334F-72	17	53 lbs	☉
	7'	86.75"	1R☒☒334F-84	22	62 lbs	☉
	8'	95.5"	1R☒☒334F-96	24	69 lbs	☉
3.5' HEIGHT	3.5'	40"	1R☒☒340F-42	9	37 lbs	☉
	4'	49.5"	1R☒☒340F-48	12	39 lbs	☉
	5'	58.75"	1R☒☒340F-60	14	51 lbs	☉
	6'	68"	1R☒☒340F-72	17	59 lbs	☉
	7'	86.75"	1R☒☒340F-84	22	69 lbs	☉
	8'	95.5"	1R☒☒340F-96	24	77 lbs	☉
4' HEIGHT	3.5'	40"	1R☒☒346F-42	9	43 lbs	☉
	4'	49.5"	1R☒☒346F-48	12	47 lbs	☉
	5'	58.75"	1R☒☒346F-60	14	58 lbs	☉
	6'	68"	1R☒☒346F-72	17	67 lbs	☉
	7'	86.75"	1R☒☒346F-84	22	76 lbs	☉
	8'	95.5"	1R☒☒346F-96	24	88 lbs	☉

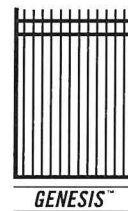
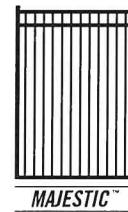
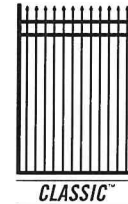

☒ = FENCE STYLES AVAILABLE | C = Classic M = Majestic G = Genesis

☒ = COLOR OPTIONS AVAILABLE | B = Black

☉ = NON-STOCKED PRODUCT

For details, see Ameristar's Sales Policy in the catalog guide.

Notes: Genesis panels are packaged with BLACK picket plugs.

effective 08-18-22

MONTAGE PLUS® | 3-RAIL SINGLE SWING GATES

3" AIR GAP | FLUSH BOTTOM | GATE HARDWARE SOLD SEPARATELY

	OPENING	LEAF WIDTH	ITEM NUMBER	PICKET QTY	WEIGHT	STOCKING
4.5' HEIGHT	3.5'	40"	1R <u>M</u> ⊗ 354F-42*	9	49 lbs	⊙
	4'	49.5"	1R <u>M</u> ⊗ 354F-48*	12	53 lbs	⊙
	5'	58.75"	1R <u>M</u> ⊗ 354F-60*	14	67 lbs	⊙
	6'	68"	1R <u>M</u> ⊗ 354F-72*	17	78 lbs	⊙
	7'	86.75"	1R <u>M</u> ⊗ 354F-84*	22	88 lbs	⊙
	8'	95.5"	1R <u>M</u> ⊗ 354F-96*	24	103 lbs	⊙
5' HEIGHT	3.5'	40"	1R <u>G</u> ⊗ 358F-42	9	51 lbs	⊙
	4'	49.5"	1R <u>G</u> ⊗ 358F-48	12	55 lbs	⊙
	5'	58.75"	1R <u>G</u> ⊗ 358F-60	14	69 lbs	⊙
	6'	68"	1R <u>G</u> ⊗ 358F-72	17	80 lbs	⊙
	7'	86.75"	1R <u>G</u> ⊗ 358F-84	22	90 lbs	⊙
	8'	95.5"	1R <u>G</u> ⊗ 358F-96	24	105 lbs	⊙
6' HEIGHT	3.5'	40"	1R <u>G</u> ⊗ 370F-42	9	60 lbs	⊙
	4'	49.5"	1R <u>G</u> ⊗ 370F-48	12	64 lbs	⊙
	5'	58.75"	1R <u>G</u> ⊗ 370F-60	14	80 lbs	⊙
	6'	68"	1R <u>G</u> ⊗ 370F-72	17	93 lbs	⊙
	7'	86.75"	1R <u>G</u> ⊗ 370F-84	22	104 lbs	⊙
	8'	95.5"	1R <u>G</u> ⊗ 370F-96	24	118 lbs	⊙

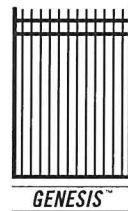
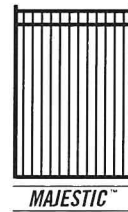
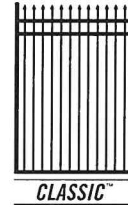

⊗ = FENCE STYLES AVAILABLE | C = Classic M = Majestic G = Genesis

⊙ = COLOR OPTIONS AVAILABLE | B = Black

⊙ = NON-STOCKED PRODUCT

For details, see Ameristar's Sales Policy in the catalog guide.

* 4.5' flush bottom gates available in Majestic only

Notes: Genesis panels are packaged with BLACK picket plugs.

effective 10-18-21

MONTAGE PLUS® | SINGLE SWING STEEL ARCHED GATE SPECIFICATIONS

1.75"sq x 14ga STEEL GATE ENDS | 1.4375" x 1.5" x 14ga RAILS | .75"sq x 18ga PICKETS | 3.5' - 6' NOMINAL OPENINGS

SINGLE SWING
 DIMENSIONAL DRAWING

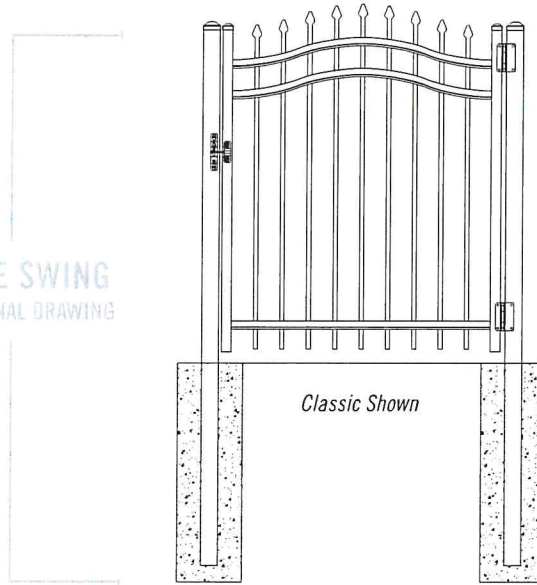

SINGLE SWING
 ARCHED
 HARDWARE KITS &
 POST INTERSPACES

OPENING	LEAF WIDTH*	CGBS-25 CGBS-3 / CGBS-4 COMMERCIAL HINGE WITH STRONG ARM			HGBS-25 HGBS-3 / HGBS-4 HEAVY COMMERCIAL HINGE KITS		
		HC	LC	P _S	HC	LC	P _S
3.5'	40"	1"	3"	44"	1.25"	3"	44.25"
4'	49.5"	1"	3"	53.5"	1.25"	3"	53.75"
5'	58.75"	1"	3"	62.75"	1.25"	3"	63"
6'	68"	1"	3"	72"	1.25"	3"	72.25"

W = width* | HC = hinge clearance | LC = latch clearance | P_S = gate post spacing**

* From outside to outside | ** From inside to inside

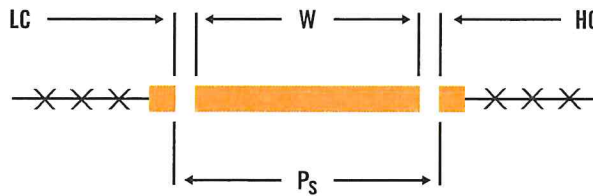

© 2015 ASSA ABLOY

MONTAGE PLUS® | DOUBLE SWING STEEL ARCHED GATE SPECIFICATIONS

1.75"sq x 14ga STEEL GATE ENDS | 1.4375" x 1.5" x 14ga RAILS | .75"sq x 18ga PICKETS | 7' - 14' NOMINAL OPENINGS

DOUBLE SWING
 DIMENSIONAL DRAWING

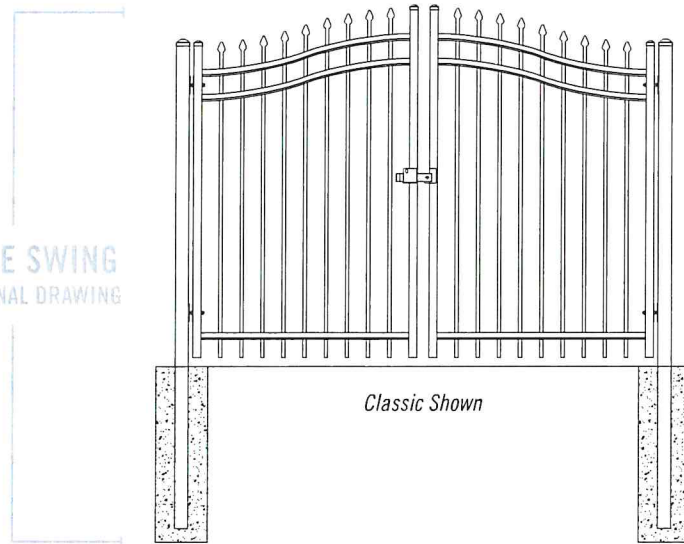

DOUBLE SWING
 HARDWARE KITS &
 POST INTERSPACES

OPENING	LEAF WIDTH*	C880 COMMERCIAL HINGE WITH STRONG ARM			H680 HEAVY COMMERCIAL HINGE KITS		
		HC	LC	P _d	HC	LC	P _d
7'	40"	1"	2"	84"	1.25"	2"	84.5"
8'	49.5"	1"	2"	103"	1.25"	2"	103.5"
10'	58.75"	1"	2"	121.5"	1.25"	2"	122"
12'	68"	1"	2"	140"	1.25"	2"	140.5"
14'	86.75"	1"	2"	177.5"	1.25"	2"	178"

W = width (x2)* | HC = hinge clearance (x2) | LC = latch clearance | P_d = gate post spacing**

* From outside to outside | ** From inside to inside

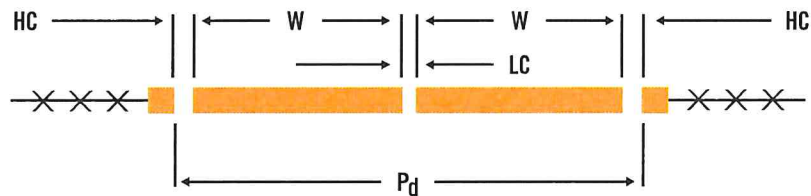

© 2016 Ameristar

MONTAGE PLUS® | 2-RAIL SINGLE SWING ARCHED GATES

4" AIR GAP | STANDARD BOTTOM | GATE HARDWARE SOLD SEPARATELY

	OPENING	LEAF WIDTH	ITEM NUMBER	PICKET QTY	WEIGHT	STOCKING
3' HEIGHT	3.5'	40"	1W☒Ⓞ234-42A	7	29 lbs	⊙
	4'	49.5"	1W☒Ⓞ234-48A	9	35 lbs	⊙
	5'	58.75"	1W☒Ⓞ234-60A	11	39 lbs	⊙
	6'	68"	1W☒Ⓞ234-72A	13	44 lbs	⊙
3.5' HEIGHT	3.5'	40"	1W☒Ⓞ240-42A	7	32 lbs	⊙
	4'	49.5"	1W☒Ⓞ240-48A	9	39 lbs	⊙
	5'	58.75"	1W☒Ⓞ240-60A	11	44 lbs	⊙
	6'	68"	1W☒Ⓞ240-72A	13	50 lbs	⊙
4' HEIGHT	3.5'	40"	1W☒Ⓞ246-42A	7	40 lbs	⊙
	4'	49.5"	1W☒Ⓞ246-48A	9	43 lbs	⊙
	5'	58.75"	1W☒Ⓞ246-60A	11	53 lbs	⊙
	6'	68"	1W☒Ⓞ246-72A	13	62 lbs	⊙
5' HEIGHT	3.5'	40"	1W☒Ⓞ258-42A	7	50 lbs	⊙
	4'	49.5"	1W☒Ⓞ258-48A	9	53 lbs	⊙
	5'	58.75"	1W☒Ⓞ258-60A	11	64 lbs	⊙
	6'	68"	1W☒Ⓞ258-72A	13	75 lbs	⊙
6' HEIGHT	3.5'	40"	1W☒Ⓞ270-42A	7	58 lbs	⊙
	4'	49.5"	1W☒Ⓞ270-48A	9	63 lbs	⊙
	5'	58.75"	1W☒Ⓞ270-60A	11	75 lbs	⊙
	6'	68"	1W☒Ⓞ270-72A	13	86 lbs	⊙

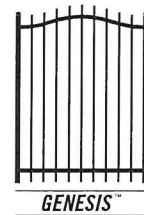
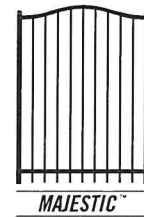
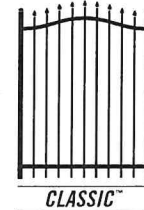

☒ = FENCE STYLES AVAILABLE | C = Classic M = Majestic G = Genesis

Ⓞ = COLOR OPTIONS AVAILABLE | B = Black

⊙ = NON-STOCKED PRODUCT

For details, see Ameristar's Sales Policy in the catalog guide.

WARNING: Steel arched gates with EXTENDED PICKET BOTTOM exposure are NOT TO BE AUTOMATED!
 Extended picket bottom treatment does not meet ASTM standard F2200 for automated gates.

Notes: Genesis panels are packaged with BLACK picket plugs.

ENCL. 10-1-12

MONTAGE PLUS[®] | 2-RAIL SINGLE SWING ARCHED GATES

4" AIR GAP | FLUSH BOTTOM | GATE HARDWARE SOLD SEPARATELY

	OPENING	LEAF WIDTH	ITEM NUMBER	PICKET QTY	WEIGHT	STOCKING
3' HEIGHT	3.5'	40"	1W☒Ⓞ234F-42A	7	29 lbs	⊙
	4'	49.5"	1W☒Ⓞ234F-48A	9	35 lbs	⊙
	5'	58.75"	1W☒Ⓞ234F-60A	11	39 lbs	⊙
	6'	68"	1W☒Ⓞ234F-72A	13	44 lbs	⊙
3.5' HEIGHT	3.5'	40"	1W☒Ⓞ240F-42A	7	32 lbs	⊙
	4'	49.5"	1W☒Ⓞ240F-48A	9	39 lbs	⊙
	5'	58.75"	1W☒Ⓞ240F-60A	11	44 lbs	⊙
	6'	68"	1W☒Ⓞ240F-72A	13	50 lbs	⊙
4' HEIGHT	3.5'	40"	1W☒Ⓞ246F-42A	7	40 lbs	⊙
	4'	49.5"	1W☒Ⓞ246F-48A	9	43 lbs	⊙
	5'	58.75"	1W☒Ⓞ246F-60A	11	53 lbs	⊙
	6'	68"	1W☒Ⓞ246F-72A	13	62 lbs	⊙
5' HEIGHT	3.5'	40"	1W☒Ⓞ258F-42A	7	50 lbs	⊙
	4'	49.5"	1W☒Ⓞ258F-48A	9	53 lbs	⊙
	5'	58.75"	1W☒Ⓞ258F-60A	11	64 lbs	⊙
	6'	68"	1W☒Ⓞ258F-72A	13	75 lbs	⊙
6' HEIGHT	3.5'	40"	1W☒Ⓞ270F-42A	7	58 lbs	⊙
	4'	49.5"	1W☒Ⓞ270F-48A	9	63 lbs	⊙
	5'	58.75"	1W☒Ⓞ270F-60A	11	75 lbs	⊙
	6'	68"	1W☒Ⓞ270F-72A	13	86 lbs	⊙

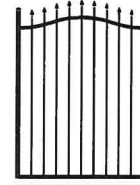

CLASSIC™

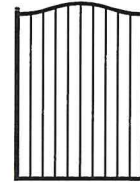

MAJESTIC™

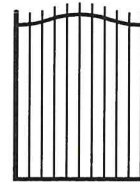

GENESIS™

☒ = FENCE STYLES AVAILABLE | C = Classic M = Majestic G = Genesis

Ⓞ = COLOR OPTIONS AVAILABLE | B = Black

⊙ = NON-STOCKED PRODUCT

For details, see Ameristar's Sales Policy in the catalog guide.

Notes: Genesis panels are packaged with BLACK picket plugs.

2/20/2019 10:44:21

MONTAGE PLUS® | 3-RAIL SINGLE SWING ARCHED GATES

4" AIR GAP | STANDARD BOTTOM | GATE HARDWARE SOLD SEPARATELY

	OPENING	LEAF WIDTH	ITEM NUMBER	PICKET QTY	WEIGHT	STOCKING
3' HEIGHT	3.5'	40"	1W☒Ⓞ334-42A	7	32 lbs	☉
	4'	49.5"	1W☒Ⓞ334-48A	9	39 lbs	☉
	5'	58.75"	1W☒Ⓞ334-60A	11	44 lbs	☉
	6'	68"	1W☒Ⓞ334-72A	13	51 lbs	☉
3.5' HEIGHT	3.5'	40"	1W☒Ⓞ340-42A	7	37 lbs	☉
	4'	49.5"	1W☒Ⓞ340-48A	9	43 lbs	☉
	5'	58.75"	1W☒Ⓞ340-60A	11	50 lbs	☉
	6'	68"	1W☒Ⓞ340-72A	13	51 lbs	☉
4' HEIGHT	3.5'	40"	1W☒Ⓞ346-42A	7	44 lbs	☉
	4'	49.5"	1W☒Ⓞ346-48A	9	48 lbs	☉
	5'	58.75"	1W☒Ⓞ346-60A	11	58 lbs	☉
	6'	68"	1W☒Ⓞ346-72A	13	68 lbs	☉
5' HEIGHT	3.5'	40"	1W☒Ⓞ358-42A	7	53 lbs	☉
	4'	49.5"	1W☒Ⓞ358-48A	9	57 lbs	☉
	5'	58.75"	1W☒Ⓞ358-60A	11	69 lbs	☉
	6'	68"	1W☒Ⓞ358-72A	13	80 lbs	☉
6' HEIGHT	3.5'	40"	1W☒Ⓞ370-42A	7	62 lbs	☉
	4'	49.5"	1W☒Ⓞ370-48A	9	67 lbs	☉
	5'	58.75"	1W☒Ⓞ370-60A	11	80 lbs	☉
	6'	68"	1W☒Ⓞ370-72A	13	94 lbs	☉



☒ = FENCE STYLES AVAILABLE | C = Classic M = Majestic G = Genesis

Ⓞ = COLOR OPTIONS AVAILABLE | B = Black

☉ = NON-STOCKED PRODUCT

For details, see Ameristar's Sales Policy in the catalog guide.

WARNING: Steel arched gates with EXTENDED PICKET BOTTOM exposure are NOT TO BE AUTOMATED!
 Extended picket bottom treatment does not meet ASTM standard F2200 for automated gates.

Notes: Genesis panels are packaged with BLACK picket plugs.

© 2018 Ameristar

MONTAGE PLUS® | 3-RAIL SINGLE SWING ARCHED GATES

4" AIR GAP | FLUSH BOTTOM | GATE HARDWARE SOLD SEPARATELY

	OPENING	LEAF WIDTH	ITEM NUMBER	PICKET QTY	WEIGHT	STOCKING
3' HEIGHT	3.5'	40"	1W☒☉334F-42A	7	32 lbs	☉
	4'	49.5"	1W☒☉334F-48A	9	39 lbs	☉
	5'	58.75"	1W☒☉334F-60A	11	44 lbs	☉
	6'	68"	1W☒☉334F-72A	13	51 lbs	☉
3.5' HEIGHT	3.5'	40"	1W☒☉340F-42A	7	37 lbs	☉
	4'	49.5"	1W☒☉340F-48A	9	43 lbs	☉
	5'	58.75"	1W☒☉340F-60A	11	50 lbs	☉
	6'	68"	1W☒☉340F-72A	13	51 lbs	☉
4' HEIGHT	3.5'	40"	1W☒☉346F-42A	7	44 lbs	☉
	4'	49.5"	1W☒☉346F-48A	9	48 lbs	☉
	5'	58.75"	1W☒☉346F-60A	11	58 lbs	☉
	6'	68"	1W☒☉346F-72A	13	68 lbs	☉
4.5' HEIGHT	3.5'	40"	1WM☒☉354F-42A*	7	51 lbs	☉
	4'	49.5"	1WM☒☉354F-48A*	9	58 lbs	☉
	5'	58.75"	1WM☒☉354F-60A*	11	67 lbs	☉
	6'	68"	1WM☒☉354F-72A*	13	78 lbs	☉
5' HEIGHT	3.5'	40"	1W☒☉358F-42A	7	53 lbs	☉
	4'	49.5"	1W☒☉358F-48A	9	57 lbs	☉
	5'	58.75"	1W☒☉358F-60A	11	69 lbs	☉
	6'	68"	1W☒☉358F-72A	13	80 lbs	☉
6' HEIGHT	3.5'	40"	1W☒☉370F-42A	7	62 lbs	☉
	4'	49.5"	1W☒☉370F-48A	9	67 lbs	☉
	5'	58.75"	1W☒☉370F-60A	11	80 lbs	☉
	6'	68"	1W☒☉370F-72A	13	94 lbs	☉



CLASSIC™



MAJESTIC™

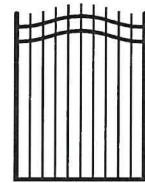

GENESIS™

☒ = FENCE STYLES AVAILABLE | C = Classic M = Majestic G = Genesis

☉ = COLOR OPTIONS AVAILABLE | B = Black

☉ = NON-STOCKED PRODUCT

For details, see Ameristar's Sales Policy in the catalog guide.

* 4.5' flush bottom gates available in Majestic only

Notes: Genesis panels are packaged with BLACK picket plugs.

© Ameristar 10-18-22

MONTAGE PLUS® | 2-RAIL DOUBLE SWING ARCHED GATES

4" AIR GAP | STANDARD BOTTOM | GATE HARDWARE SOLD SEPARATELY

	OPENING	LEAF WIDTH	ITEM NUMBER	PICKET QTY	WEIGHT	STOCKING
3' HEIGHT	7'	40"	1W☒Ⓣ234-84HD	14	58 lbs	☉
	8'	49.5"	1W☒Ⓣ234-96HD	18	68 lbs	☉
	10'	58.75"	1W☒Ⓣ234-120HD	22	76 lbs	☉
	12'	68"	1W☒Ⓣ234-144HD	26	86 lbs	☉
	14'	86.75"	1W☒Ⓣ234-168HD	34	102 lbs	☉
3.5' HEIGHT	7'	40"	1W☒Ⓣ240-84HD	14	64 lbs	☉
	8'	49.5"	1W☒Ⓣ240-96HD	18	76 lbs	☉
	10'	58.75"	1W☒Ⓣ240-120HD	22	86 lbs	☉
	12'	68"	1W☒Ⓣ240-144HD	26	96 lbs	☉
	14'	86.75"	1W☒Ⓣ240-168HD	34	112 lbs	☉
4' HEIGHT	7'	40"	1W☒Ⓣ246-84HD	14	78 lbs	☉
	8'	49.5"	1W☒Ⓣ246-96HD	18	84 lbs	☉
	10'	58.75"	1W☒Ⓣ246-120HD	22	102 lbs	☉
	12'	68"	1W☒Ⓣ246-144HD	26	118 lbs	☉
	14'	86.75"	1W☒Ⓣ246-168HD	34	130 lbs	☉
5' HEIGHT	7'	40"	1W☒Ⓣ258-84HD	14	98 lbs	☉
	8'	49.5"	1W☒Ⓣ258-96HD	18	104 lbs	☉
	10'	58.75"	1W☒Ⓣ258-120HD	22	122 lbs	☉
	12'	68"	1W☒Ⓣ258-144HD	26	142 lbs	☉
	14'	86.75"	1W☒Ⓣ258-168HD	34	154 lbs	☉
6' HEIGHT	7'	40"	1W☒Ⓣ270-84HD	14	114 lbs	☉
	8'	49.5"	1W☒Ⓣ270-96HD	18	122 lbs	☉
	10'	58.75"	1W☒Ⓣ270-120HD	22	142 lbs	☉
	12'	68"	1W☒Ⓣ270-144HD	26	164 lbs	☉
	14'	86.75"	1W☒Ⓣ270-168HD	34	180 lbs	☉

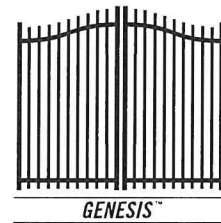
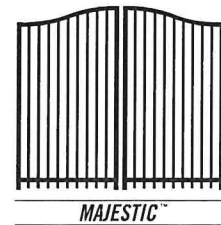
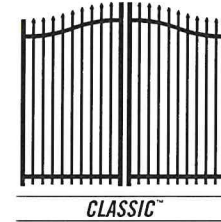

☒ = FENCE STYLES AVAILABLE | ☒ = Classic | M = Majestic | G = Genesis

Ⓣ = COLOR OPTIONS AVAILABLE | B = Black

☉ = NON-STOCKED PRODUCT

For details, see Ameristar's Sales Policy in the catalog guide.

WARNING: Steel arched gates with EXTENDED PICKET BOTTOM exposure are NOT TO BE AUTOMATED! Extended picket bottom treatment does not meet ASTM standard F2200 for automated gates.

Notes: Genesis panels are packaged with BLACK picket plugs. Two gate leaves included for all double gates. Gate heights are nominal & gate widths are actual. For details about gate hardware that **MUST BE ORDERED SEPARATELY** for these gates, see the Montage Plus Arched Gate introduction at the beginning of this section.

ET&S 10/16/21

MONTAGE PLUS® | 2-RAIL DOUBLE SWING ARCHED GATES

4" AIR GAP | FLUSH BOTTOM | GATE HARDWARE SOLD SEPARATELY

	OPENING	LEAF WIDTH	ITEM NUMBER	PICKET QTY	WEIGHT	STOCKING
3' HEIGHT	7'	40"	1W☒Ⓞ234F-84HD	14	58 lbs	☉
	8'	49.5"	1W☒Ⓞ234F-96HD	18	68 lbs	☉
	10'	58.75"	1W☒Ⓞ234F-120HD	22	76 lbs	☉
	12'	68"	1W☒Ⓞ234F-144HD	26	86 lbs	☉
	14'	86.75"	1W☒Ⓞ234F-168HD	34	102 lbs	☉
3.5' HEIGHT	7'	40"	1W☒Ⓞ240F-84HD	14	64 lbs	☉
	8'	49.5"	1W☒Ⓞ240F-96HD	18	76 lbs	☉
	10'	58.75"	1W☒Ⓞ240F-120HD	22	86 lbs	☉
	12'	68"	1W☒Ⓞ240F-144HD	26	96 lbs	☉
	14'	86.75"	1W☒Ⓞ240F-168HD	34	112 lbs	☉
4' HEIGHT	7'	40"	1W☒Ⓞ246F-84HD	14	78 lbs	☉
	8'	49.5"	1W☒Ⓞ246F-96HD	18	84 lbs	☉
	10'	58.75"	1W☒Ⓞ246F-120HD	22	102 lbs	☉
	12'	68"	1W☒Ⓞ246F-144HD	26	118 lbs	☉
	14'	86.75"	1W☒Ⓞ246F-168HD	34	130 lbs	☉
5' HEIGHT	7'	40"	1W☒Ⓞ258F-84HD	14	98 lbs	☉
	8'	49.5"	1W☒Ⓞ258F-96HD	18	104 lbs	☉
	10'	58.75"	1W☒Ⓞ258F-120HD	22	122 lbs	☉
	12'	68"	1W☒Ⓞ258F-144HD	26	142 lbs	☉
	14'	86.75"	1W☒Ⓞ258F-168HD	34	154 lbs	☉
6' HEIGHT	7'	40"	1W☒Ⓞ270F-84HD	14	114 lbs	☉
	8'	49.5"	1W☒Ⓞ270F-96HD	18	122 lbs	☉
	10'	58.75"	1W☒Ⓞ270F-120HD	22	142 lbs	☉
	12'	68"	1W☒Ⓞ270F-144HD	26	164 lbs	☉
	14'	86.75"	1W☒Ⓞ270F-168HD	34	180 lbs	☉

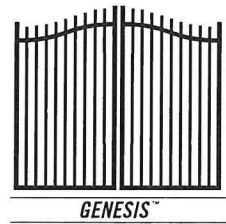
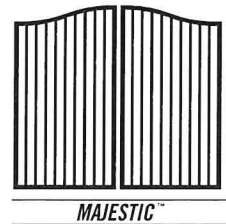
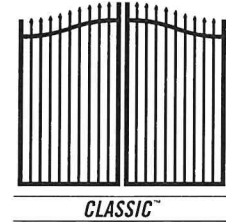

☒ = FENCE STYLES AVAILABLE | C = Classic M = Majestic G = Genesis

Ⓞ = COLOR OPTIONS AVAILABLE | B = Black

☉ = NON-STOCKED PRODUCT

For details, see Ameristar's Sales Policy in the catalog guide.

Notes: Genesis panels are packaged with BLACK picket plugs. Two gate leaves included for all double gates. Gate heights are nominal & gate widths are actual. For details about gate hardware that **MUST BE ORDERED SEPARATELY** for these gates, see the Montage Plus Arched Gate introduction at the beginning of this section.

MONTAGE PLUS® | 3-RAIL DOUBLE SWING ARCHED GATES

4" AIR GAP | STANDARD BOTTOM | GATE HARDWARE SOLD SEPARATELY

	OPENING	LEAF WIDTH	ITEM NUMBER	PICKET QTY	WEIGHT	STOCKING
3' HEIGHT	7'	40"	1W☒Ⓞ334-84HD	14	64 lbs	☉
	8'	49.5"	1W☒Ⓞ334-96HD	18	76 lbs	☉
	10'	58.75"	1W☒Ⓞ334-120HD	22	86 lbs	☉
	12'	68"	1W☒Ⓞ334-144HD	26	98 lbs	☉
	14'	86.75"	1W☒Ⓞ334-168HD	34	118 lbs	☉
3.5' HEIGHT	7'	40"	1W☒Ⓞ340-84HD	14	72 lbs	☉
	8'	49.5"	1W☒Ⓞ340-96HD	18	84 lbs	☉
	10'	58.75"	1W☒Ⓞ340-120HD	22	96 lbs	☉
	12'	68"	1W☒Ⓞ340-144HD	26	108 lbs	☉
	14'	86.75"	1W☒Ⓞ340-168HD	34	128 lbs	☉
4' HEIGHT	7'	40"	1W☒Ⓞ346-84HD	14	86 lbs	☉
	8'	49.5"	1W☒Ⓞ346-96HD	18	92 lbs	☉
	10'	58.75"	1W☒Ⓞ346-120HD	22	112 lbs	☉
	12'	68"	1W☒Ⓞ346-144HD	26	130 lbs	☉
	14'	86.75"	1W☒Ⓞ346-168HD	34	144 lbs	☉
5' HEIGHT	7'	40"	1W☒Ⓞ358-84HD	14	104 lbs	☉
	8'	49.5"	1W☒Ⓞ358-96HD	18	112 lbs	☉
	10'	58.75"	1W☒Ⓞ358-120HD	22	132 lbs	☉
	12'	68"	1W☒Ⓞ358-144HD	26	152 lbs	☉
	14'	86.75"	1W☒Ⓞ358-168HD	34	168 lbs	☉
6' HEIGHT	7'	40"	1W☒Ⓞ370-84HD	14	120 lbs	☉
	8'	49.5"	1W☒Ⓞ370-96HD	18	130 lbs	☉
	10'	58.75"	1W☒Ⓞ370-120HD	22	152 lbs	☉
	12'	68"	1W☒Ⓞ370-144HD	26	178 lbs	☉
	14'	86.75"	1W☒Ⓞ370-168HD	34	194 lbs	☉

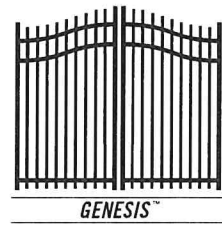
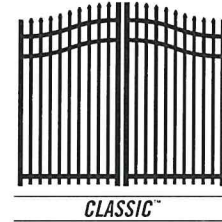

☒ = FENCE STYLES AVAILABLE | ☐ = Classic | ☑ = Majestic | ☒ = Genesis

Ⓞ = COLOR OPTIONS AVAILABLE | B = Black

☉ = NON-STOCKED PRODUCT

For details, see Ameristar's Sales Policy in the catalog guide.

WARNING: Steel arched gates with EXTENDED PICKET BOTTOM exposure are NOT TO BE AUTOMATED!
 Extended picket bottom treatment does not meet ASTM standard F2200 for automated gates.

Notes: Genesis panels are packaged with BLACK picket plugs. Two gate leaves included for all double gates. Gate heights are nominal & gate widths are actual. For details about gate hardware that **MUST BE ORDERED SEPARATELY** for these gates, see the Montage Plus Arched Gate introduction at the beginning of this section.

effective 10/1/20

MONTAGE PLUS® | 3-RAIL DOUBLE SWING ARCHED GATES

4" AIR GAP | FLUSH BOTTOM | GATE HARDWARE SOLD SEPARATELY

	OPENING	LEAF WIDTH	ITEM NUMBER	PICKET QTY	WEIGHT	STOCKING
3' HEIGHT	7'	40"	1W☒☒334F-84HD	14	64 lbs	☉
	8'	49.5"	1W☒☒334F-96HD	18	76 lbs	☉
	10'	58.75"	1W☒☒334F-120HD	22	86 lbs	☉
	12'	68"	1W☒☒334F-144HD	26	98 lbs	☉
	14'	86.75"	1W☒☒334F-168HD	34	118 lbs	☉
3.5' HEIGHT	7'	40"	1W☒☒340F-84HD	14	72 lbs	☉
	8'	49.5"	1W☒☒340F-96HD	18	84 lbs	☉
	10'	58.75"	1W☒☒340F-120HD	22	96 lbs	☉
	12'	68"	1W☒☒340F-144HD	26	108 lbs	☉
	14'	86.75"	1W☒☒340F-168HD	34	128 lbs	☉
4' HEIGHT	7'	40"	1W☒☒346F-84HD	14	86 lbs	☉
	8'	49.5"	1W☒☒346F-96HD	18	92 lbs	☉
	10'	58.75"	1W☒☒346F-120HD	22	112 lbs	☉
	12'	68"	1W☒☒346F-144HD	26	130 lbs	☉
	14'	86.75"	1W☒☒346F-168HD	34	144 lbs	☉
4.5' HEIGHT	7'	40"	1WM☒☒354F-84HD*	14	98 lbs	☉
	8'	49.5"	1WM☒☒354F-96HD*	18	106 lbs	☉
	10'	58.75"	1WM☒☒354F-120HD*	22	130 lbs	☉
	12'	68"	1WM☒☒354F-144HD*	26	150 lbs	☉
	14'	86.75"	1WM☒☒354F-168HD*	34	164 lbs	☉
5' HEIGHT	7'	40"	1W☒☒358F-84HD	14	104 lbs	☉
	8'	49.5"	1W☒☒358F-96HD	18	112 lbs	☉
	10'	58.75"	1W☒☒358F-120HD	22	132 lbs	☉
	12'	68"	1W☒☒358F-144HD	26	152 lbs	☉
	14'	86.75"	1W☒☒358F-168HD	34	168 lbs	☉
6' HEIGHT	7'	40"	1W☒☒370F-84HD	14	120 lbs	☉
	8'	49.5"	1W☒☒370F-96HD	18	130 lbs	☉
	10'	58.75"	1W☒☒370F-120HD	22	152 lbs	☉
	12'	68"	1W☒☒370F-144HD	26	178 lbs	☉
	14'	86.75"	1W☒☒370F-168HD	34	194 lbs	☉

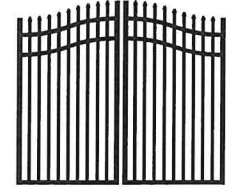

CLASSIC™

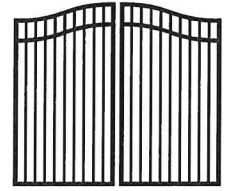

MAJESTIC™



GENESIS™

* 4.5' flush bottom gates available in Majestic only

Notes: Genesis panels are packaged with BLACK picket plugs. Two gate leaves included for all double gates. Gate heights are nominal & gate widths are actual. For details about gate hardware that **MUST BE ORDERED SEPARATELY** for these gates, see the Montage Plus Arched Gate introduction at the beginning of this section.

Effective 10-18-21

MONTAGE PLUS® | SINGLE SWING STEEL ESTATE GATE SPECIFICATIONS

2"sq x 12ga STEEL GATE ENDS | 1.4375"w x 1.5"h x 14ga RAILS | .75"sq x 14ga PICKETS | 8' - 12' NOMINAL OPENINGS

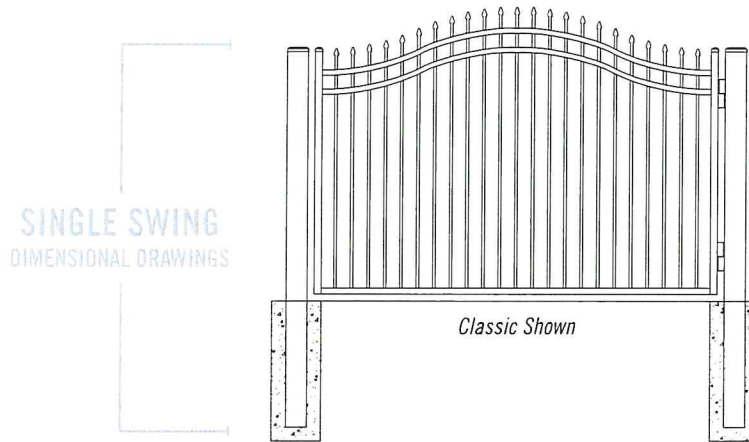

SINGLE SWING
 ESTATE
 HARDWARE KITS &
 POST INTERSPACES

OPENING	LEAF WIDTH*	CGBS-25 CGBS-3 / CGBS-4 COMMERCIAL HINGE WITH STRONG ARM			HGBS-25 HGBS-3 / HGBS-4 HEAVY COMMERCIAL HINGE KITS		
		HC	LC	P _S	HC	LC	P _S
8'	95.5"	1"	3"	99.5"	1.25"	3"	99.75"
10'	114.75"	1"	3"	118.75"	1.25"	3"	119"
12'	143"	1"	3"	147"	1.25"	3"	147.25"

W = width* | HC = hinge clearance | LC = latch clearance | P_S = gate post spacing**

* From outside to outside | ** From inside to inside

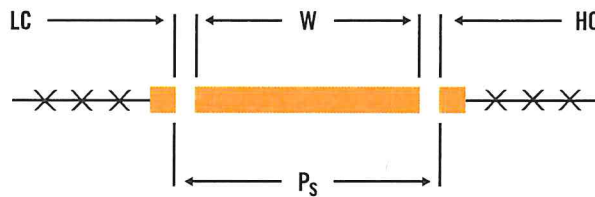

Circle 10 on page 2

MONTAGE PLUS® | DOUBLE SWING STEEL ESTATE GATE SPECIFICATIONS

2"sq x 12ga STEEL GATE ENDS | 1.4375"w x 1.5"h x 14ga RAILS | .75"sq x 14ga PICKETS | 16' - 24' NOMINAL OPENINGS

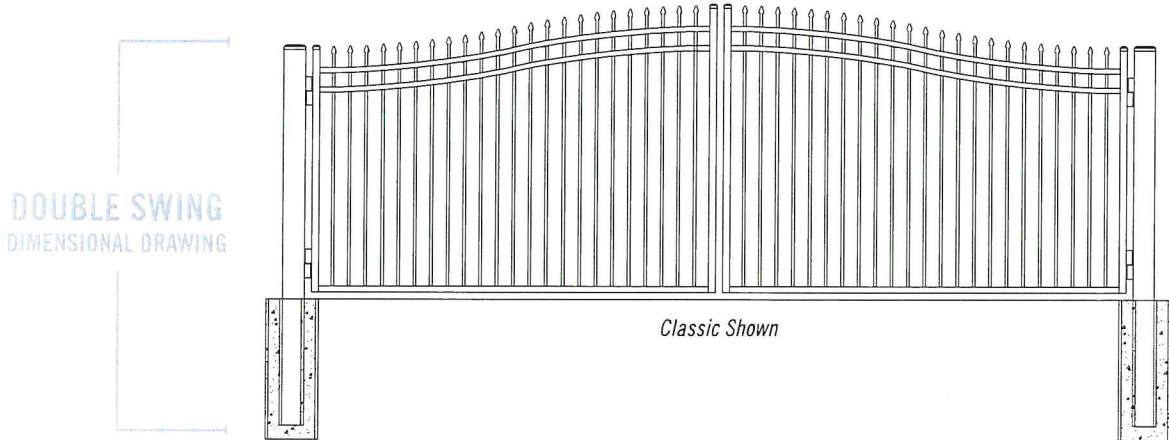

DOUBLE SWING ESTATE HARDWARE KITS & POST INTERSPACES

OPENING	LEAF WIDTH*	CGBD COMMERCIAL HINGE WITH STRONG ARM			HGBD HEAVY COMMERCIAL HINGE KITS		
		HC	LC	P _d	HC	LC	P _d
16'	95.5"	1"	2"	195"	1.25"	2"	195.5"
18'	105.5"	1"	2"	215"	1.25"	2"	215.5"
20'	114.75"	1"	2"	233.5"	1.25"	2"	234"
22'	133.5"	1"	2"	271"	1.25"	2"	271.5"
24'	143"	1"	2"	290"	1.25"	2"	290.5"

W = width (x2)* | HC = hinge clearance (x2) | LC = latch clearance | P_d = gate post spacing**
 * From outside to outside | ** From inside to inside

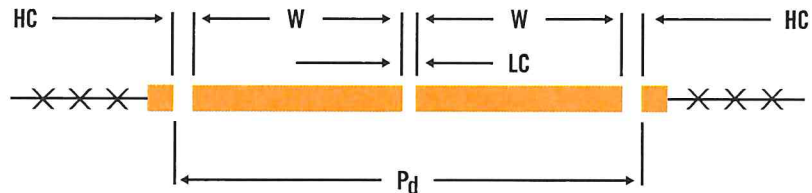

effa.2.16.01-11.22

MONTAGE PLUS® | 3-RAIL SINGLE SWING ESTATE ENTRY GATES

4" AIR GAP | FLUSH BOTTOM | GATE HARDWARE SOLD SEPARATELY

	OPENING	LEAF WIDTH	ITEM NUMBER	PICKET QTY	WEIGHT	STOCKING
4' HEIGHT	8'	95.5"	1W☒☒346F-96A	19	66 lbs	☉
	10'	114.75"	1W☒☒346F-120A	23	75 lbs	☉
	12'	143"	1W☒☒346F-144A	29	87 lbs	☉
4.5' HEIGHT	8'	95.5"	1WM☒354F-96A*	19	70 lbs	☉
	10'	114.75"	1WM☒354F-120A*	23	80 lbs	☉
	12'	143"	1WM☒354F-144A*	29	92 lbs	☉
5' HEIGHT	8'	95.5"	1W☒☒358F-96A	19	75 lbs	☉
	10'	114.75"	1W☒☒358F-120A	23	85 lbs	☉
	12'	143"	1W☒☒358F-144A	29	97 lbs	☉
6' HEIGHT	8'	95.5"	1W☒☒370F-96A	19	84 lbs	☉
	10'	114.75"	1W☒☒370F-120A	23	95 lbs	☉
	12'	143"	1W☒☒370F-144A	29	108 lbs	☉

☒ = FENCE STYLES AVAILABLE | **C** = Classic | **M** = Majestic | **G** = Genesis

☒ = COLOR OPTIONS AVAILABLE | **B** = Black

☉ = NON-STOCKED PRODUCT

For details, see Ameristar's Sales Policy in the catalog guide.

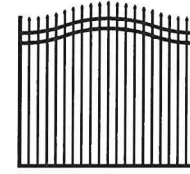

CLASSIC™



MAJESTIC™



GENESIS™

* 4.5' flush bottom gates available in Majestic only

Notes: The above Steel Estate Entry Gates match Montage Plus 3 Rail Flush Bottom fence panels. Genesis panels are packaged with BLACK picket plugs. These steel estate entry gates are designed in COMPLIANCE WITH INDUSTRY STANDARDS FOR AUTOMATIC GATES AS OUTLINE BY UL325 & ASTM F2200

creative dr / 1/21

MONTAGE PLUS® | 3-RAIL DOUBLE SWING ESTATE ENTRY GATES

4" AIR GAP | FLUSH BOTTOM | GATE HARDWARE SOLD SEPARATELY

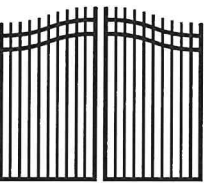
	OPENING	LEAF WIDTH	ITEM NUMBER	PICKET QTY	WEIGHT	STOCKING	
4' HEIGHT	16'	95.5"	1W☒☉346F-192HD	38	200 lbs	☉	 CLASSIC™
	18'	105.5"	1W☒☉346F-216HD	42	216 lbs	☉	
	20'	114.75"	1W☒☉346F-240HD	46	232 lbs	☉	
	22'	133.5"	1W☒☉346F-264HD	54	263 lbs	☉	
	24'	143"	1W☒☉346F-288HD	58	279 lbs	☉	
4.5' HEIGHT	16'	95.5"	1WM☒☉354F-192HD*	38	224 lbs	☉	 MAJESTIC™
	18'	105.5"	1WM☒☉354F-216HD*	42	242 lbs	☉	
	20'	114.75"	1WM☒☉354F-240HD*	46	259 lbs	☉	
	22'	133.5"	1WM☒☉354F-264HD*	54	294 lbs	☉	
	24'	143"	1WM☒☉354F-288HD*	58	312 lbs	☉	
5' HEIGHT	16'	95.5"	1W☒☉358F-192HD	38	236 lbs	☉	 GENESIS™
	18'	105.5"	1W☒☉358F-216HD	42	254 lbs	☉	
	20'	114.75"	1W☒☉358F-240HD	46	273 lbs	☉	
	22'	133.5"	1W☒☉358F-264HD	54	309 lbs	☉	
	24'	143"	1W☒☉358F-288HD	58	327 lbs	☉	
6' HEIGHT	16'	95.5"	1W☒☉370F-192HD	38	271 lbs	☉	
	18'	105.5"	1W☒☉370F-216HD	42	293 lbs	☉	
	20'	114.75"	1W☒☉370F-240HD	46	313 lbs	☉	
	22'	133.5"	1W☒☉370F-264HD	54	355 lbs	☉	
	24'	143"	1W☒☉370F-288HD	58	376 lbs	☉	

☒ = FENCE STYLES AVAILABLE | C = Classic M = Majestic G = Genesis

☉ = COLOR OPTIONS AVAILABLE | B = Black

☉ = NON-STOCKED PRODUCT

For details, see Ameristar's Sales Policy in the catalog guide.

* 4.5' flush bottom gates available in Majestic only

Notes: The above Steel Estate Entry Gates match Montage Plus 3 Rail Flush Bottom fence panels. Genesis panels are packaged with BLACK picket plugs. These steel estate entry gates are designed in COMPLIANCE WITH INDUSTRY STANDARDS FOR AUTOMATIC GATES AS OUTLINE BY UL325 & ASTM F2200. Two gate leaves included for all double gates. Gate heights are nominal & gate widths are actual.

Effective 08-18-22

MONTAGE PLUS® | 4-RAIL SINGLE SWING ESTATE ENTRY GATES

4" AIR GAP | FLUSH BOTTOM | GATE HARDWARE SOLD SEPARATELY

	OPENING	LEAF WIDTH	ITEM NUMBER	PICKET QTY	WEIGHT	STOCKING
4' HEIGHT	8'	95.5"	1W☒☉446F-96A	19	74 lbs	☉
	10'	114.75"	1W☒☉446F-120A	23	86 lbs	☉
	12'	143"	1W☒☉446F-144A	29	100 lbs	☉
4.5' HEIGHT	8'	95.5"	1WM☉454F-96A*	19	79 lbs	☉
	10'	114.75"	1WM☉454F-120A*	23	91 lbs	☉
	12'	143"	1WM☉454F-144A*	29	105 lbs	☉
5' HEIGHT	8'	95.5"	1W☒☉458F-96A	19	83 lbs	☉
	10'	114.75"	1W☒☉458F-120A	23	96 lbs	☉
	12'	143"	1W☒☉458F-144A	29	110 lbs	☉
6' HEIGHT	8'	95.5"	1W☒☉470F-96A	19	92 lbs	☉
	10'	114.75"	1W☒☉470F-120A	23	106 lbs	☉
	12'	143"	1W☒☉470F-144A	29	121 lbs	☉

4'
HEIGHT
4.5'
HEIGHT
5'
HEIGHT
6'
HEIGHT

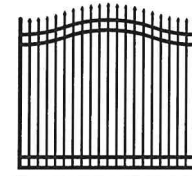

CLASSIC™

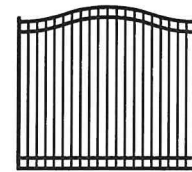

MAJESTIC™



GENESIS™

☒ = FENCE STYLES AVAILABLE | C = Classic M = Majestic G = Genesis

☉ = COLOR OPTIONS AVAILABLE | B = Black

☉ = NON-STOCKED PRODUCT

For details, see Ameristar's Sales Policy in the catalog guide.

* 4.5' flush bottom gates available in Majestic only

Notes: Genesis panels are packaged with BLACK picket plugs. These steel estate entry gates are designed in COMPLIANCE WITH INDUSTRY STANDARDS FOR AUTOMATIC GATES AS OUTLINE BY UL325 & ASTM F2200. Third rail from the top on the above Steel Estate Entry Gates matches Montage Plus 3-Rail extended picket fence panels.

2174-001-10-15-11

MONTAGE PLUS® | 4-RAIL DOUBLE SWING ESTATE ENTRY GATES

4" AIR GAP | FLUSH BOTTOM | GATE HARDWARE SOLD SEPARATELY

	OPENING	LEAF WIDTH	ITEM NUMBER	PICKET QTY	WEIGHT	STOCKING
4' HEIGHT	16'	95.5"	1W☒Ⓞ446F-192HD	38	215 lbs	☉
	18'	105.5"	1W☒Ⓞ446F-216HD	42	233 lbs	☉
	20'	114.75"	1W☒Ⓞ446F-240HD	46	250 lbs	☉
	22'	133.5"	1W☒Ⓞ446F-264HD	54	285 lbs	☉
	24'	143"	1W☒Ⓞ446F-288HD	58	302 lbs	☉
4.5' HEIGHT	16'	95.5"	1WMⓄ454F-192HD*	38	239 lbs	☉
	18'	105.5"	1WMⓄ454F-216HD*	42	259 lbs	☉
	20'	114.75"	1WMⓄ454F-240HD*	46	278 lbs	☉
	22'	133.5"	1WMⓄ454F-264HD*	54	316 lbs	☉
	24'	143"	1WMⓄ454F-288HD*	58	335 lbs	☉
5' HEIGHT	16'	95.5"	1W☒Ⓞ458F-192HD	38	251 lbs	☉
	18'	105.5"	1W☒Ⓞ458F-216HD	42	271 lbs	☉
	20'	114.75"	1W☒Ⓞ458F-240HD	46	291 lbs	☉
	22'	133.5"	1W☒Ⓞ458F-264HD	54	331 lbs	☉
	24'	143"	1W☒Ⓞ458F-288HD	58	351 lbs	☉
6' HEIGHT	16'	95.5"	1W☒Ⓞ470F-192HD	38	286 lbs	☉
	18'	105.5"	1W☒Ⓞ470F-216HD	42	309 lbs	☉
	20'	114.75"	1W☒Ⓞ470F-240HD	46	332 lbs	☉
	22'	133.5"	1W☒Ⓞ470F-264HD	54	377 lbs	☉
	24'	143"	1W☒Ⓞ470F-288HD	58	399 lbs	☉

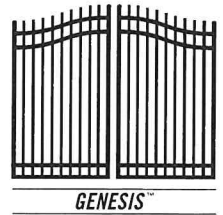
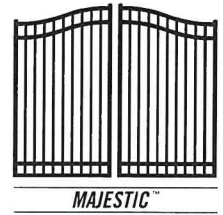
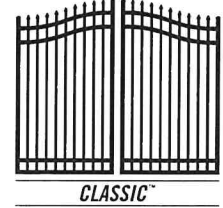

☒ = FENCE STYLES AVAILABLE | C = Classic M = Majestic G = Genesis

Ⓞ = COLOR OPTIONS AVAILABLE | B = Black

☉ = NON-STOCKED PRODUCT

For details, see Ameristar's Sales Policy in the catalog guide.

* 4.5' flush bottom gates available in Majestic only

Notes: Genesis panels are packaged with BLACK picket plugs. These steel estate entry gates are designed in COMPLIANCE WITH INDUSTRY STANDARDS FOR AUTOMATIC GATES AS OUTLINE BY UL325 & ASTM F2200. Third rail from the top on the above Steel Estate Entry Gates matches Montage Plus. 3-Rail extended picket fence panels. Two gate leaves included for all double gates. Gate heights are nominal & gate widths are actual.

Effective 06-18-22

MONTAGE PLUS® | GATE ENDS

1.75" x 14ga | GATES FABRICATED BY WELDING GATE ENDS TO PANEL REMNANTS ARE EXCLUDED FROM THE WARRANTY

SIZE	ITEM NUMBER	BOX QTY	WEIGHT
1.75" x 34"	1H⊗234	8	2.90 lbs
1.75" x 40"	1H⊗240	8	3.45 lbs
1.75" x 46"	1H⊗246	8	3.83 lbs
1.75" x 58"	1H⊗258	8	4.00 lbs
1.75" x 70"	1H⊗270	8	4.95 lbs
1.75" x 71"	1H⊗271	8	5.00 lbs

⊗ = COLOR OPTIONS AVAILABLE | B = Black

Notes: 1.75" sq. pressed steel post caps are included in box for each gate end

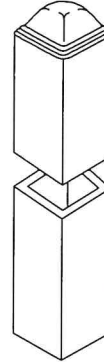

effective 10-16-22

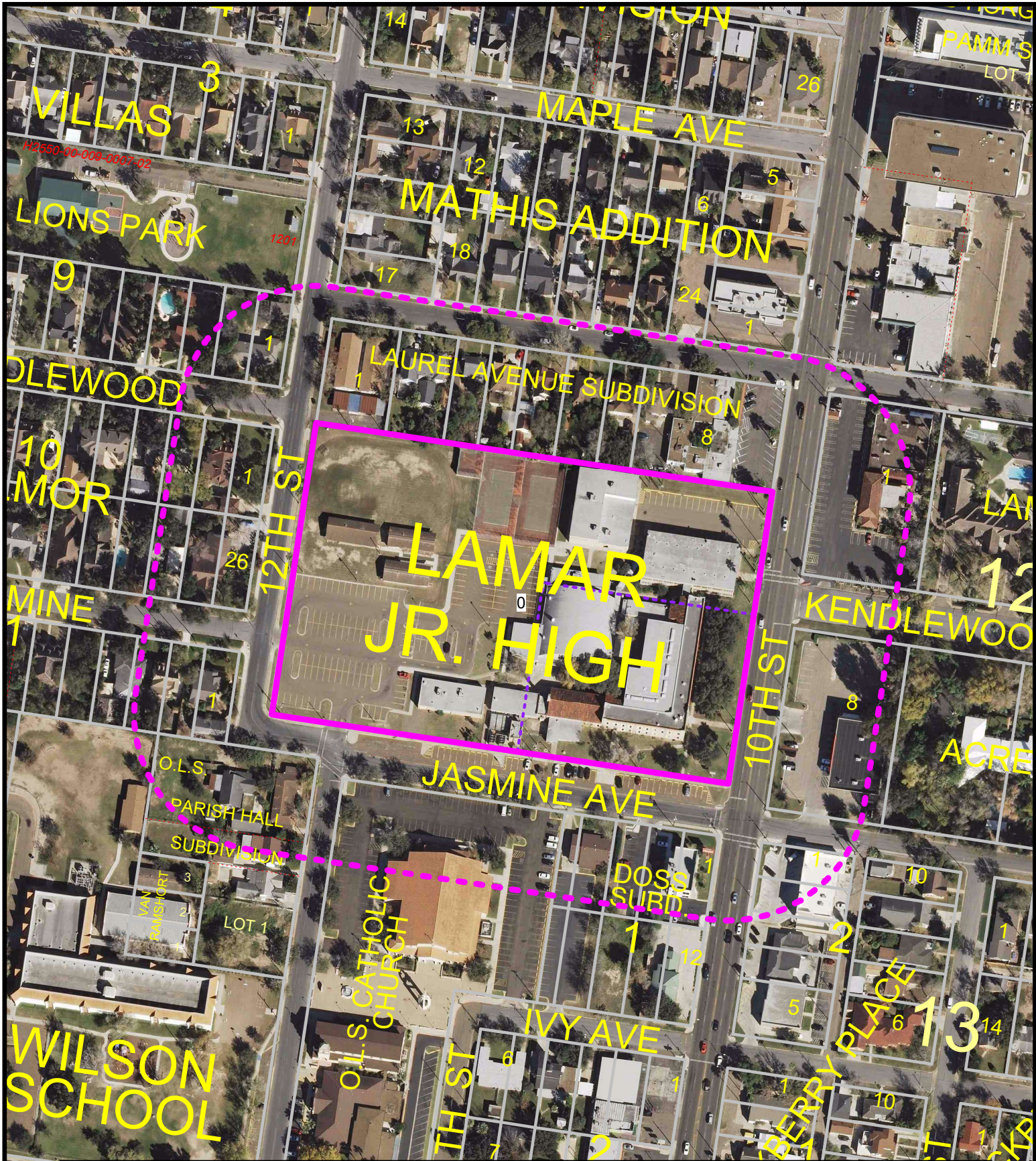

CITY OF McALLEN
PLANNING DEPARTMENT

AERIAL MAP
SCALE: N.T.S.

 SUBJECT PROPERTY

 200 FT. NOTIFICATION BOUNDARY



This map is a representation of the official zoning map. For zoning verification contact the Planning Department at 956-681-1250, or select city maps at <http://www.mcallen.net>. Furthermore, this map is for informational purposes and is not prepared for or suitable for legal, engineering, or surveying purposes. It does not represent an on ground survey and represent approximate relative location of property boundaries.

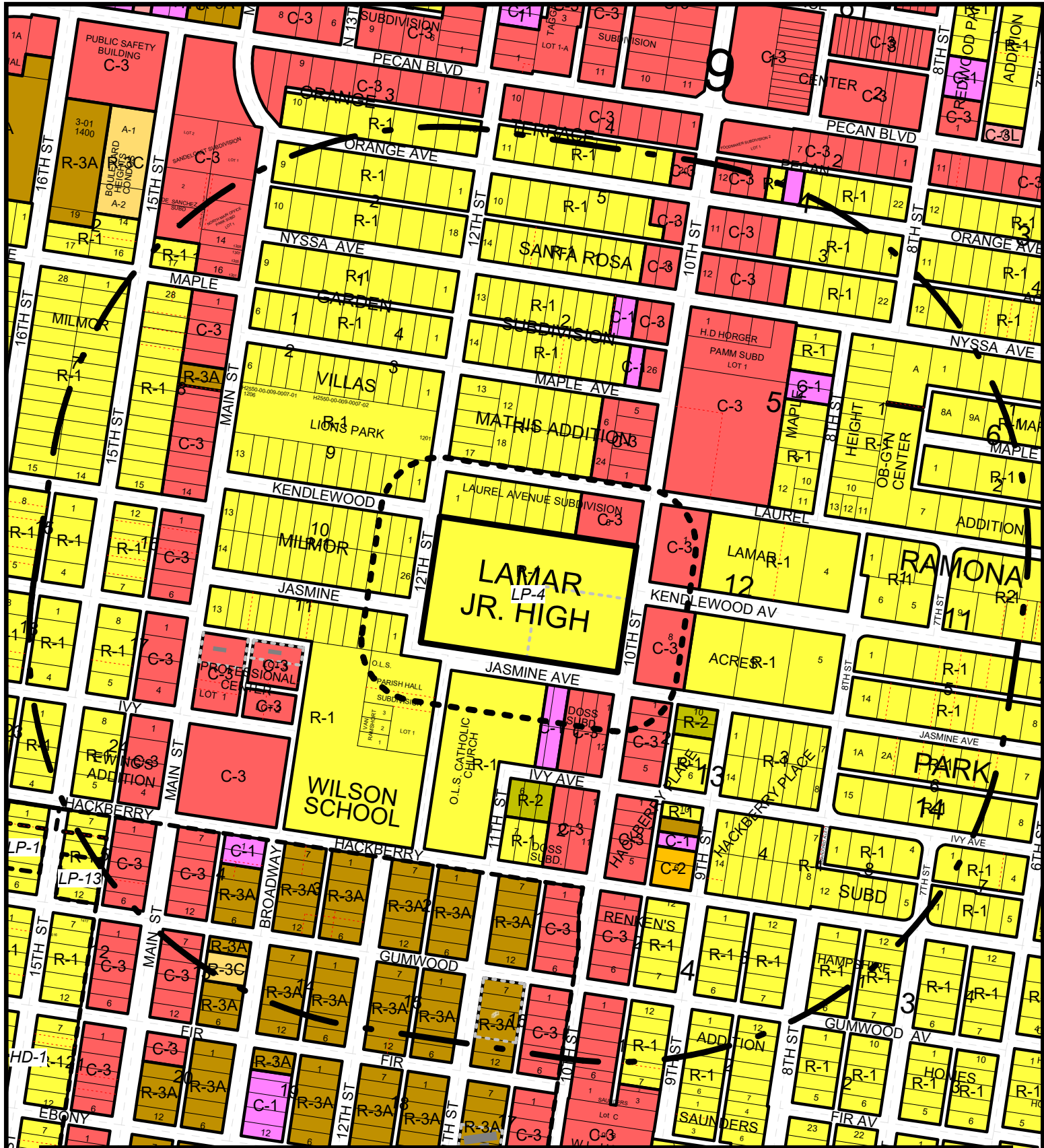

CITY OF McALLEN
PLANNING DEPARTMENT

AREA MAP

LEGEND
SCALE: N.T.S.



SUBJECT PROPERTY	200 FT. NOTIFICATION BOUNDARY	1/4 MILE RADIUS	(SPECIAL DISTRICT)
ZONING LEGEND			
A-0 (AGRICULTURAL & OPEN SPACE)	R-3A (APARTMENTS)	R-4 (MOBILE HOMES)	C-3 (GENERAL BUSINESS)
R-1 (SINGLE FAMILY RESIDENTIAL)	R-3C (CONDOMINIUMS)	C-1 (OFFICE BUILDING)	C-3/ECOD (GENERAL BUSINESS/ECOD)
R-2 (DUPLIX-FOURPLEX)	R-3T (TOWNHOUSES)	C-2 (NEIGHBORHOOD COMMERCIAL)	C-4 (COMMERCIAL INDUSTRIAL)
		C-3L (LIGHT COMMERCIAL)	I-1 (LIGHT INDUSTRIAL)
			I-2 (HEAVY INDUSTRIAL)

This map is a representation of the official zoning map. For zoning verification contact the Planning Department at 956-681-1250, or select city maps at <http://www.mcalLEN.net>. Furthermore, this map is for informational purposes and is not prepared for or suitable for legal, engineering, or surveying purposes. It does not represent an on ground survey and represent approximate relative location of property boundaries.

